

EnerGenius® iQ2

Automatic Battery Charger & DC Supply 12 to 240 Volts Nominal, 6 to 150 Amps



Installation & Operation Manual

SENS Part Number: 101340-1
Document Revision: E
DCN Number: 108515
Date: 5/21/2024

MADE IN U.S.A
PATENTED US 9,270,140; 9,385,556; 9,413,186; 9,509,164;
9,466,995; 9,948,125

Installation or service questions?

Call SENS between 8 a.m. and 5 p.m. (Mountain Time),
Monday through Friday or visit our website.



1840 Industrial Circle
Longmont, CO 80501
Phone: 303.678.7500
800.742.2326
Fax: 303.678.7504
Email: service@sens-usa.com
Web: www.sens-usa.com

Copyright © Stored Energy Systems LLC 2021

The SENS name / logo, EnerGenius, HELIX, and Dynamic Boost are trademarks of Stored Energy Systems LLC

TABLE OF CONTENTS

1	IMPORTANT SAFETY INSTRUCTIONS FOR INSTALLER AND OPERATOR	4
2	QUICK INSTALLATION GUIDE	6
3	PERFORMANCE SPECIFICATIONS	7
4	MODEL NUMBER BREAKOUT	8
5	MECHANICAL INSTALLATION	9
5.1.	Lifting	9
5.2.	Charger Mounting Options	9
5.3.	Ventilation	9
5.4.	Environmental Considerations	9
6	ELECTRICAL INSTALLATION	9
6.1.	AC Input Connections	9
6.2.	DC Output Connections	11
6.3.	Alarm Wiring	12
6.4.	Operating Chargers in Parallel	14
6.5.	CANbus and RS-485 Connections— <i>Optional</i>	14
6.6.	Ethernet— <i>Optional</i>	16
6.7.	SENSbus Connection	17
6.8.	Remote Temperature Sensor Connection— <i>Optional</i>	19
6.9.	USB Connection	20
7	POWER ON/POWER OFF PROCEDURES	20
7.1.	Verify Input AC Supply	20
7.2.	Output/Battery Voltage	20
7.3.	Verify Charger Output	20
7.4.	Verify Configuration	20
7.5.	Begin Charging	21
7.6.	Power Off	21
8	ALARMS, LEDS AND DISPLAY	22
8.1.	Front Panel User Interface	22
8.2.	LCD Panel	22
8.3.	AC and DC LED Indicators	23
8.4.	Mimic Panel LEDs	24
8.5.	Individual Alarm Relay Contacts	24
8.6.	Latched Alarms	24
8.7.	Alarm Definitions	24
9	OPERATION	31
9.1.	Charging Algorithms	31
9.2.	Float Mode	31
9.3.	Dynamic Boost™ Mode	31
9.4.	HELIX Mode	32
9.5.	Charging Low or Zero-volt Batteries	32
9.6.	Commissioning Batteries	33
9.7.	Battery Check	33
9.8.	Restore Factory Defaults	33
9.9.	Keypad Operation	34
9.9.3.	Menu Options	34
9.10.	Configuration with SENS Setup Utility	40
9.11.	Protocol Communications Circuit Board	40
9.12.	Temperature Compensation	42
9.13.	Load Share Charger Operation	42
10	MODBUS COMMUNICATIONS	44
10.1.	TCP/IP Modbus— <i>Optional</i>	44
10.2.	RS-485 Modbus— <i>Optional</i>	44
10.3.	Modbus Holding Registers	45
10.4.	Basic Charging Alarms Bit Definition	46
10.5.	Charging Status Bit Definition	47

10.6.	Charging Alarms Extended Bit Definition	48
10.7.	Charging AC Alarms Bit Definition.....	48
10.8.	Accessory Channel Alarms Bit Definition	49
10.9.	Accessory System Alarms Bit Definition.....	49
10.10.	Accessory Assigned Channel Alarms Bit Definition	49
10.11.	Writable Control Flags (Coils).....	50
10.12.	Legacy IQ Modbus.....	50
11	DNP3 COMMUNICATIONS	56
11.1.	TCP/IP DNP3— <i>Optional</i>	56
11.2.	RS-485 DNP3— <i>Optional</i>	56
11.3.	SENS DNP3 Config Tool	56
11.4.	Implementation Table.....	57
11.5.	Binary Inputs	58
11.6.	Binary Outputs	60
11.7.	Analog Inputs	61
11.8.	Analog Outputs	62
12	MAINTENANCE AND TROUBLESHOOTING	63
12.1.	Troubleshooting Charts.....	64
12.2.	Configuration Error Codes.....	72
13	GLOSSARY.....	74

1 IMPORTANT SAFETY INSTRUCTIONS FOR INSTALLER AND OPERATOR

- 1.1. **SAVE THESE INSTRUCTIONS** – This manual contains important safety and operating instructions for EnerGenius® IQ2 battery chargers.
- 1.2. Before using battery charger, read all instructions and cautionary markings on battery charger, battery, and product using battery.
- 1.3. Do not expose charger to rain or snow.
- 1.4. Use of an attachment not recommended or sold by the battery charger manufacturer may result in a risk of fire, electric shock, or injury to persons.
- 1.5. **This charger is intended for commercial and industrial use. ONLY TRAINED AND QUALIFIED PERSONNEL MAY INSTALL AND SERVICE THIS UNIT.**
- 1.6. **GROUNDING INSTRUCTIONS** - This battery charger must be connected to a grounded metal permanent wiring system or an equipment-grounding conductor run with circuit conductors and connected to equipment-grounding terminal on battery charger. Connections to the battery charger must comply with all local codes and ordinances.
- 1.7. Do not operate charger if it has received a sharp blow, been dropped, or otherwise damaged in any way; shut off power at the branch circuit protectors and have the unit serviced or replaced by qualified personnel.
- 1.8. To reduce risk of electric shock, disconnect the branch circuit feeding the charger before attempting any maintenance or cleaning. Turning off controls will not reduce this risk.
- 1.9. **WARNING – HEATSINKS AND OTHER METALLIC SURFACES WITHIN THE CHARGER MAY BE ENERGIZED AT HIGH VOLTAGE POTENTIALS, WHICH CAN BE LETHAL. DO NOT TOUCH EXPOSED METAL SURFACES WITHIN THE CHARGER WHILE EITHER INPUT POWER OR BATTERY IS APPLIED.**
- 1.10. **WARNING – RISK OF EXPLOSIVE GASES**
 - 1.10.1. **WORKING IN THE VICINITY OF A LEAD-ACID OR NICKEL-CADMIUM BATTERY IS DANGEROUS. STORAGE BATTERIES GENERATE EXPLOSIVE GASES DURING NORMAL BATTERY OPERATION. FOR THIS REASON, IT IS OF UTMOST IMPORTANCE THAT YOU READ THIS MANUAL AND FOLLOW THE INSTRUCTIONS EACH TIME YOU USE THE CHARGER.**
 - 1.10.2. To reduce the risk of battery explosion, follow these instructions and those published by the battery manufacturer and the manufacturer of any equipment you intend to use in the vicinity of a battery. Review cautionary markings on these products and on the engine.
- 1.11. **PERSONAL PRECAUTIONS**
 - 1.11.1. Someone should be within range of your voice or close enough to come to your aid when you work near a storage battery.
 - 1.11.2. Have plenty of fresh water and soap nearby in case battery electrolyte contacts skin, clothing, or eyes.
 - 1.11.3. Wear complete eye protection and clothing protection. Avoid touching eyes while working near a storage battery.
 - 1.11.4. If battery electrolyte contacts skin or clothing, wash immediately with soap and water. If electrolyte enters eye, immediately flood the eye with running cold water for at least 10 minutes and get medical attention immediately.
 - 1.11.5. **NEVER** smoke or allow a spark or flame in vicinity of battery or engine.
 - 1.11.6. Be extra cautious to reduce risk of dropping a metal tool onto the battery. It might spark or short

circuit the battery or another electrical part that may cause explosion. Using insulated tools reduces this risk but will not eliminate it.

- 1.11.7. Remove personal metal items such as rings, bracelets, necklaces, and watches when working with a storage battery. A storage battery can produce a short circuit current high enough to weld a ring or the like to metal, causing a severe burn.
- 1.11.8. **When charging batteries, charge LEAD-ACID, LIQUID ELECTROLYTE NICKEL-CADMIUM, or SODIUM-CHLORIDE batteries only.** Consult SENS before using with any other type of battery - other batteries may burst and cause injuries to persons and damage to property.
- 1.11.9. **NEVER** charge a frozen battery.
- 1.11.10. The charger contains a DC output fuse for *internal* fault protection, but this will not protect the DC wiring from fault currents available *from the battery*. Consult national and local ordinances to determine if additional battery fault protection is necessary in your installation.

1.12. Preparing Battery for Charge

- 1.12.1. Be sure area around battery is well ventilated while battery is being charged.
- 1.12.2. Ensure battery terminals are clean and properly tightened. Be careful to keep corrosion from coming in contact with eyes.
- 1.12.3. Add distilled water in each cell until battery acid reaches level specified by battery manufacturer. Do not overfill. For a battery without removable cell caps, such as valve regulated lead acid batteries, carefully follow manufacturer's recharging instructions.
- 1.12.4. Study all battery manufacturer specific precautions such as removing or not removing cell caps while charging and recommended rate of charge. The recommended charge current range must include the rated output current of the charger.

1.13. Charger Location

- 1.13.1. Locate the charger as far away from the battery as DC cables permit.
 - 1.13.2. Never place the charger directly above or below the battery being charged; gases from the battery will corrode and damage charger.
 - 1.13.3. Never allow battery acid to drip on charger when reading electrolyte specific gravity or filling battery.
 - 1.13.4. Do not operate charger in a closed-in area or restrict ventilation in any way.
 - 1.13.5. Do not set anything on top of the charger.
- 1.14. Notice to users in the European Union: Declaration of Conformity limits the use of chargers to non-public power grids.

2 QUICK INSTALLATION GUIDE

- 2.1. Read all cautionary warnings in section 1.
- 2.2. Remove the charger from the packaging and inspect for damage. See section 5.1 for information on moving and lifting the charger. Notify SENS immediately (1-800-742-2326) if damage from shipping is evident.
- 2.3. See section 5.2 for mounting options.
- 2.4. Adjust input voltage jumper or wiring if necessary.

NOTICE:
WHEN THE INPUT JUMPER OR WIRING IS MOVED, THE “NOMINAL VOLTS AC” SETTING MUST BE ADJUSTED USING THE FRONT PANEL KEYPAD. UNDER THE MAIN “AC” MENU, NAVIGATE TO THE “BASIC SETTINGS” MENU AND THEN THE “NOMINAL VOLTS AC” MENU TO SELECT THE NOMINAL AC INPUT VOLTAGE THAT WILL BE CONNECTED TO THE CHARGER.

All 120/208/240V (input codes P and T) models include a 3-way AC input voltage selection jumper. Ensure the AC voltage selection jumpers are in the correct position for your AC supply as shown below:

VOLTAGE SELECT JUMPER SETTINGS

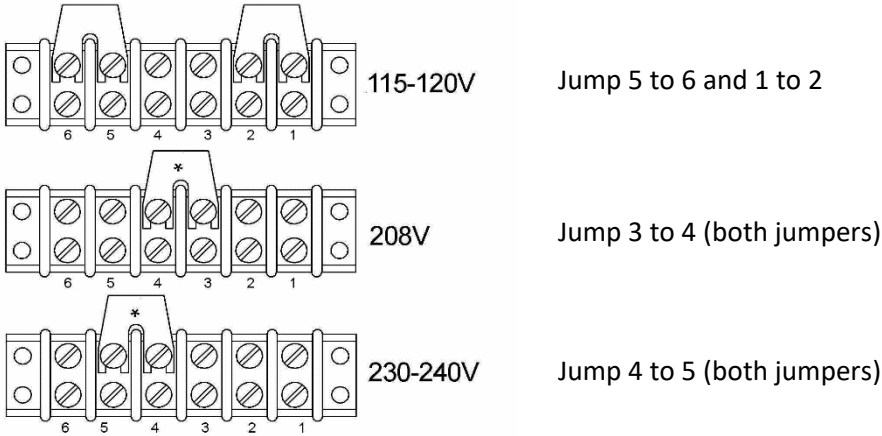

* BOTH JUMPERS IN SAME POSITION

All 208/240V 60Hz (input code Z) models include a dual AC input voltage selection terminal block. Ensure the AC voltage wire is in the correct position for your AC supply as shown below:

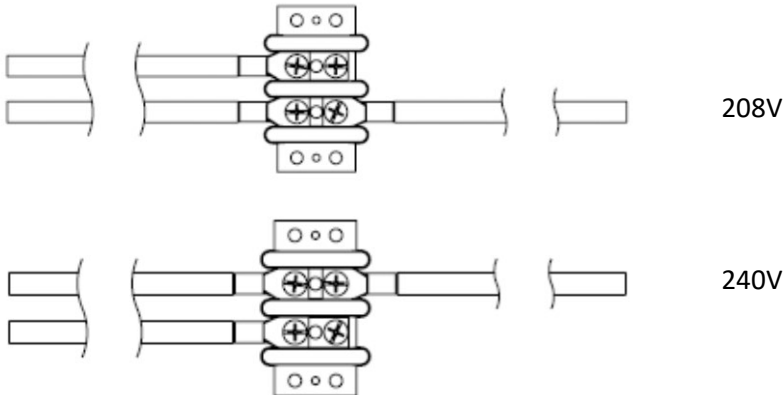

- 2.5. Connect AC wires—**Ensure that the AC input supply is de-energized and the charger AC input circuit breaker is opened.** Wire the AC input circuit to the empty lugs of the AC input breaker. Connect the earthed conductor of the AC input circuit to the grounding lug inside the charger. See the [AC Input Wire Gauge Ratings table](#) for AC input breaker wire size. See diagrams at back of manual for wiring and breaker location.
- 2.6. Connect DC wires—**Ensure that any battery disconnect device in the system, if used, is opened** (batteries disconnected from DC bus), and that the **DC output breaker in the charger is opened.** Connect the DC output wires to the load side of the DC output breaker, **observing the correct polarity** as labeled on the charger. Make sure the small signal leads also attached to the breaker remain connected. See the [DC Output Wire Gauge Ratings table](#) for DC output breaker wire sizes. See diagrams at back of manual for wiring and breaker location.
- 2.7. Connect optional alarm wires—Alarm wiring enters the charger on the upper left side of the enclosure. Knock out the conduit opening and connect alarm wiring, taking care to route the wiring through appropriate cable guides provided within the charger. See diagrams at back of manual for alarm wiring. See [Alarm Relay Contact Wiring](#) for alarm wiring connection locations.
- 2.8. Energize the AC input supply at supply panel—**With the charger input AC and output DC breakers still opened,** energize the AC input supply, and check the voltage at the line (left) side of the input AC breaker, making sure it is the correct value for the charger.
- 2.9. Verify battery voltage—**With the charger input AC and output DC breakers still opened,** close any system battery disconnect, if used, and measure the battery voltage at the battery (left) side of the charger DC output circuit breaker, making sure it is near the nominal DC voltage rating of the charger.
- 2.10. Verify battery polarity—**With the DC output circuit breaker still opened,** close charger AC breaker to start charger. The charger status display will come on and the charger will execute its initialization routines. The charger output should ramp up to within 5% of battery voltage. It will not ramp up to the float voltage setting until the DC circuit breaker is closed.

NOTE:

If a reverse polarity alarm is present on the front panel LCD, the polarity of the battery connection to the charger is incorrect. Turn off the AC power source and correct the reverse polarity problem.

- 2.11. Close the DC output breaker—Depending on the state of charge of the batteries and the load on the DC bus, the charger may go into current limit at this time, in which case the output voltage as displayed on the LCD will be reduced as the charger operates in constant current mode. Eventually as the battery is charged, the charging current demand should taper to a value below the current limit set point of the charger, and the charger should revert to constant voltage output.
- 2.12. See section [9.6](#) to initially charge/commission zero charge batteries.
- 2.13. If automatic boost charging is desired, configure boost mode using the front panel (see section [9.9.3](#)).
- 2.14. It is highly recommended that for proper operation of two chargers connected in parallel to the same battery that one charger is connected to the second charger with a digital load-sharing cable. **The digital load sharing cable should never be connected when two chargers are each connected to different batteries.**

3 PERFORMANCE SPECIFICATIONS

See the [IQ2 Product Data Sheet and Product Specification](#) on the SENS website (www.sens-usa.com) for detailed performance specifications.

4 MODEL NUMBER BREAKOUT

Q	024	050	T	L	5	1	4	A	R
A	B	C	D	E	F	G	H	I	J

Field	Parameter	Code	Value
A	Product Family	Q	EnerGenius IQ
B	Output Voltage	012	12 volts
		024	24 volts
		048	48 volts
		120	120 volts
		240	240 volts
C	Output Current	006	6 amps
		012	12 amps
		016	16 amps
		025	25 amps
		035	35 amps
		050	50 amps
		075	75 amps
		100	100 amps
150	150 amps		
D	Input Voltage	T	115-120/208/230-240V 60Hz
		P	115-120/208/230-240V 50/60Hz
		Z	208/240V 60Hz
		8	480V 60Hz
		V	400V 50/60Hz
		4	230-240V 50/60Hz
E	Agency Approval	L	60Hz, UL 1012, C-UL
		H	60Hz, UL 1236, C-UL
		G	50/60Hz, UL 1012, C-UL and CE mark (includes inrush limiting)
		J	50/60Hz, UL 1236, C-UL and CE mark (includes inrush limiting, available on 12V and 24V units only)
		S	Special
F	Compliance Option	5	Standard
		6	PIP compliance (requires 7+1 or 12+1 alarm relay option)
G	Input Breaker Interrupt Option	1	Standard interrupt breaker (inrush limiter with 50/60Hz only)
		3	Medium interrupt (18-25 KAIC) breaker & inrush limiter
		7	High interrupt (65 KAIC) breaker & inrush limiter
H	Output Filter/Blocking Diode Configuration	1	Standard filter, no diodes
		2	Low ripple filter, no diodes
		3	Standard filter, blocking and reverse diodes
		4	Low ripple filter, blocking and reverse diodes
I	Alarm Relay/Communications Option	A	Summary alarm only
		C	7 relays (30V/2A) + 1 relay (120VAC/5A)
		L	Remote Temp Sense + Load-sharing network cable
		K	Options C and L
		M	5 Relays (30V/2A) + Modbus 10/100Base-T and RS-485
		N	Options C and M
J	Special Options	E	OSHPPD labeled
		H	10kA min interrupt DC output breaker
		R	Rack Mount

5 MECHANICAL INSTALLATION

5.1. Lifting

The Q1 case size (19 inch) charger is designed to be lifted from the bottom by pallet jack or lift truck.

The Q2 case size (23 inch) charger is designed to be lifted either from the bottom by pallet jack or lift truck or from the top via a strap and hook arrangement attached to four 3/8-inch eyebolts (not provided) installed in the top of the unit. See drawings at back of manual for eyebolt installation locations.

5.2. Charger Mounting Options

The Q1 case size charger is designed to mount on a wall using wall mount flanges on the sides of the chassis. Rack mounting is orderable as a factory option.

The Q2 case size charger is designed to accommodate either wall or floor mounting. The charger has integral wall mounting flanges on the sides of the chassis. Rack mounting is orderable as a factory option. Floor pieces are orderable as optional kits.

See drawings at back of manual for details on mounting configurations. Do not mount the charger in locations subject to high vibration. Do not mount the charger directly to the frame of an engine or generator set.

5.3. Ventilation

The charger is designed to be convection cooled. Required clearances around the unit for proper cooling are 6 inches on the top and 4 inches on the bottom.

5.4. Environmental Considerations

The charger should be installed in a sheltered area, protected from rain and snow. The suggested operating temperature range is $-20^{\circ}\text{C}/-4^{\circ}\text{F}$ to $+50^{\circ}\text{C}/122^{\circ}\text{F}$, but the charger will operate safely outside of this range. The charger is rated for $-40^{\circ}\text{C}/-40^{\circ}\text{F}$ for black/cold start, and once it self-heats to $-20^{\circ}\text{C}/-4^{\circ}\text{F}$ is guaranteed to meet all published specifications. The charger thermal limiter reduces output current to prevent overheating when ambient temperature is too high.

6 ELECTRICAL INSTALLATION

WARNING:

BEFORE ELECTRICAL INSTALLATION, ENSURE THE FOLLOWING:

- A. AC MAINS SUPPLY CIRCUIT IS DE-ENERGIZED
- B. AC INPUT BREAKER ON THE CHARGER IS OPENED
- C. DC OUTPUT BREAKER ON THE CHARGER IS OPENED
- D. BATTERY DISCONNECT, IF USED, IS OPENED (BATTERY REMOVED FROM DC BUS)

IMPORTANT! The charger is configured at the factory and typically requires no adjustments before operating. Refer to the label on the door for factory configured output and alarm relay assignments. The charger may be reconfigured using the front panel keypad or by software programming using the SENS Setup Utility. See drawings at back of manual for quick reference installation information. Diagrams reflect charger setup for a typical installation only. For applications not covered in the diagram, please consult charger supplier.

6.1. AC Input Connections

The battery charger is designed to be permanently connected to an appropriately rated single phase, grounded AC mains circuit. Wiring used must be sized appropriately for the charger input current and must be selected to meet any applicable local codes (see [AC Input Current and AC/DC Circuit Breaker Current Ratings](#) for charger circuit breaker ratings and the [AC Input Wire Gauge Ratings table](#) for recommended wire gauges). Connect to the line side of the input circuit breaker and ground lug via conduit knockout openings on the lower left side of the charger enclosure (see diagrams at back of manual). The earthed conductor of the AC mains circuit must be connected to

the charger-grounding terminal. Input (AC line) wiring must be kept at least 1/4" (6.3 mm) away from all output, alarm, data interface wiring, and from other uninsulated electrical parts not connected to the input conductor.

AC input tolerance is -12%, +6% for 60Hz models based on standard North American line voltages of 120V, 208V, 240V, and 480V and ±10% for 50/60Hz models based on standard European line voltages of 230V and 400V. Rated input frequency for all units is ±5%.

AC Input Current and AC/DC Circuit Breaker Current Ratings

Charger Model	Rated AC Input Current					*AC Input Branch Circuit Breaker Ratings							Charger Input Breaker Current Ratings					Charger Output Breaker Current Ratings
	208V 60Hz (3), 208/240V 60Hz (Z)	230/240V 50/60 Hz (4), 60Hz (S)	480V 60Hz (8)	120/208/240V 50/60 Hz (P), 60Hz (T)	400V 50/60 Hz (V)	208V 60Hz (3), 208/240V 60Hz (Z)	230/240V 50/60 Hz (4), 60Hz (S)	480V 60Hz (8)	120V 50/60 Hz (P), 60Hz (T)	208V 50/60 Hz (P), 60Hz (T)	240V 50/60 Hz (P), 60Hz (T)	400V 50/60 Hz (V)	208V 60Hz (3), 208/240V 60Hz (Z)	230/240V 50/60 Hz (4), 60Hz (S)	480V 60Hz (8)	120/208/240V 50/60 Hz (P), 60Hz (T)	400V 50/60 Hz (V)	
Q012-012			0.8	3.2/1.8/1.6	1.0			15	10, 15	10, 15	10, 15	15			15	10, 15	15	15
Q012-016			1.0	4.2/2.4/2.1	1.2			15	10, 15	10, 15	10, 15	15			15	10, 15	15	20
Q012-025			1.6	6.3/3.6/3.1	1.9			15	10, 15	10, 15	10, 15	15			15	10, 15	15	35
Q012-035			2.1	8.5/4.9/4.3	2.6			15	15	10, 15	10, 15	15			15	15	15	45
Q012-050			3.1	13/7.2/6.3	3.8			15	20	10, 15	10, 15	15			15	20	15	70
Q012-075	N/A	N/A	4.6	18/11/9.1	5.5	N/A	N/A	15	25	15	15	15	N/A	N/A	15	25	15	100
Q012-100	N/A	N/A	6.1	24/14/12	7.3	N/A	N/A	15	30	20	15	15	N/A	N/A	15	30	15	125
Q012-150	N/A	N/A	9.0	36/21/18	11	N/A	N/A	15	45	30	25	15	N/A	N/A	15	45	15	200
Q024-006			0.7	2.9/1.7/1.5	0.9			15	10, 15	10, 15	10, 15	15			15	10, 15	15	10
Q024-012			1.4	5.6/3.2/2.8	1.7			15	10, 15	10, 15	10, 15	15			15	10, 15	15	15
Q024-016			1.8	7.4/4.3/3.7	2.2			15	10, 15	10, 15	10, 15	15			15	10, 15	15	20
Q024-025			2.9	12/6.7/5.8	3.5			15	15	10, 15	10, 15	15			15	15	15	35
Q024-035			4.0	16/9.1/7.9	4.7			15	20	15	10, 15	15			15	20	15	45
Q024-050			5.6	23/13/11	6.8			15	30	20	15	15			15	30	15	70
Q024-075	N/A	N/A	8.3	33/19/17	9.9	N/A	N/A	15	45	25	25	15	N/A	N/A	15	45	15	100
Q024-100	N/A	N/A	11	44/25/22	13	N/A	N/A	15	60	35	30	20	N/A	N/A	15	60	20	125
Q024-150	37	32	16	N/A	19	50	40	20	N/A	N/A	N/A	25	50	40	20	N/A	25	200
Q048-006			1.3	5.2/3.0/2.6	1.6			15	10, 15	10, 15	10, 15	15			15	10, 15	15	10
Q048-012			2.6	10/5.9/5.1	3.1			15	15	10, 15	10, 15	15			15	15	15	15
Q048-016			3.3	13/7.7/6.7	4.0			15	20	10, 15	10, 15	15			15	20	15	20
Q048-025			5.2	21/12/10	6.2			15	30	15	15	15			15	30	15	35
Q048-035			7.1	29/17/14	8.6			15	40	25	20	15			15	40	15	45
Q048-050			10	40/23/20	12			15	50	30	25	15			15	50	15	70
Q048-075	34.1	30	15	N/A	18	45	40	20	N/A	N/A	N/A	25	45	40	20	N/A	25	100
Q048-100	45	39	20	N/A	24	60	50	25	N/A	N/A	N/A	30	60	50	25	N/A	30	125
Q120-006			3.1	12/7.0/6.1	3.7			15	15	10, 15	10, 15	15			15	15	15	15
Q120-012			5.9	24/14/12	7.0			15	30	20	15	15			15	30	15	15
Q120-016			7.8	31/18/16	9.4			15	40	25	20	15			15	40	15	20
Q120-025			12	47/27/24	14			15	60	35	30	20			15	60	20	35
Q120-035	38	33	17	N/A	20	50	45	25	N/A	N/A	N/A	25	50	45	25	N/A	25	45
Q120-050	54	46	23	N/A	28	70	60	30	N/A	N/A	N/A	40	70	60	30	N/A	35	70
Q240-006			5.9	24/14/12	7.0			15	30	20	15	15			15	30	15	15
Q240-012			11	44/26/23	14			15	60	35	30	20			15	60	20	15
Q240-016	35	30	15	N/A	18	50	40	20	N/A	N/A	N/A	25	45	40	20	N/A	25	20
Q240-025	54	46	23	N/A	28	70	60	30	N/A	N/A	N/A	40	70	60	30	N/A	35	35

*User must incorporate a branch circuit breaker external to the charger to provide a mode of disconnection from the supply mains.

NOTE:

Breakers designated as “10, 15” indicate a 10 Amp breaker for input code T and a 15 Amp breaker for input code P.

AC Input Wire Gauge Ratings

Rated Charger Input	Wire Gauge	
	Min	Max
≤ 240 VAC, ≤ 24A	# 14 Cu or Al	#2 Cu or Al
≤ 240 VAC, 60 Hz, > 24A	# 14 Cu or Al	#2 Cu or Al
≤ 240 VAC, 50/60 Hz, > 24A	# 14 Cu, #12 Al	# 1/0 Cu or Al
> 240 VAC (all)	# 14 Cu, #12 Al	#2 Cu, #4 Al
All 65 KAIC Breakers (Special Order)	# 14 Cu, #12 Al	# 1/0 Cu or Al

NOTE:

This table represents only the physical capabilities of the terminals. In addition to the physical limitations, conductors must be electrically adequate per local electrical safety regulations (such as the National Electrical Code®).

6.2. DC Output Connections

WARNING:

OBSERVE PROPER POLARITY WHEN CONNECTING THE BATTERY CIRCUIT TO THE CHARGER. FAILURE TO DO SO COULD RESULT IN EXPLOSION AND DAMAGE TO THE BATTERY CHARGER. SHOULD THE BATTERY CONNECTIONS BE REVERSED, AN ALARM WILL BE PRESENT ON THE FRONT PANEL LCD WHEN AC POWER IS APPLIED. IF PRESENT, RECHECK BATTERY AND SENSE LEAD CONNECTIONS TO OUTPUT BREAKER FOR PROPER POLARITY BEFORE CLOSING THE DC CIRCUIT BREAKER OR OPERATING THE CHARGER.

The battery charger is designed for permanent connection to the battery and DC load circuit. Wiring used must be sized appropriately for the charger output current and must be selected to meet any applicable local codes (see [AC Input Current and AC/DC Circuit Breaker Current Ratings](#) for circuit breaker ratings and [DC Output Wire Gauge Ratings](#) for wire gauges). Connection is made to the load side of the output circuit breaker via conduit knockout openings on the lower left side of the charger enclosure. Proper polarity for connection to the circuit breaker is labeled on the inside of the charger near the output circuit breaker. Output (DC battery) wiring must be kept at least 1/4" (6.3mm) away from all alarm and data interface wiring, and from other uninsulated electrical parts not connected to the output conductor.

240VDC battery chargers typically use 3-pole output circuit breakers and are configured for floating or negative DC grounded systems. Move breaker connections for positive grounded systems as shown below.

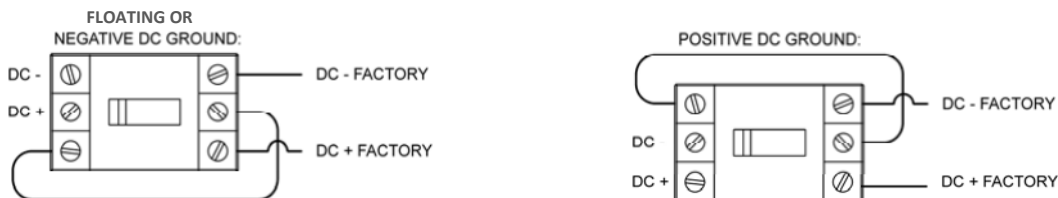

The battery may be disconnected (for test or replacement purposes) while leaving the charger powered on without interrupting the load. With battery disconnected, on charger with 2-stage filter, the maximum transient voltage deviation is 5% of initial voltage when subjected to load current changes between 20% to 100% and 100% to 20% of full rated load current. Recovery to within 1% of steady state voltage is within 200 milliseconds. Transient response in units with battery eliminator output filter is slower.

CAUTION:

Small sense leads are connected to the load (output) side of the DC output circuit breaker. These must remain connected with the proper polarity after installation of the output power DC wiring or the charger will not function properly.

NOTE:

If required for your installation, either the positive or the negative charger output may be connected to earth ground. If this is done, the ground fault alarm must be disabled to prevent a false alarm (see section [9.9.3](#) to configure ground fault alarm).

DC Output Wire Gauge Ratings

Rated Charger Output		Wire Gauge	
Volts	Current	Min	Max
12V - 48V	≤ 50A	# 14 Cu or Al	# 2 Cu or Al
	75 & 100A	# 4 Cu or Al	# 2/0 Cu or Al
	150A	#4 Cu Only	# 4/0 Cu Only
120V & 240V	≤ 16A	# 14 Cu, #12 Al	# 4 Cu or Al
	≥ 25A	# 14 Cu, #12 Al	# 1/0 Cu or Al

CAUTION:

Output terminals on 150A models are approved for use with copper conductors only. Do not use aluminum output conductors for 150A models.

NOTE:

The [DC Output Wire Gauge Ratings table](#) represents only the physical capabilities of the terminals. In addition to the physical limitations, conductors must be electrically adequate per local electrical safety regulations (such as the National Electrical Code®).

6.3. Alarm Wiring

Each charger comes standard with one summary alarm on the control circuit board that allows the user to monitor several alarms at once with one set of dry contacts. Additional alarm relay package options are available. The optional alarm relay circuit board includes seven discrete Form C contacts rated 2A at 30V AC or DC plus one additional relay rated 5A at 120VAC. The 120VAC/5A relay is configured at the factory as a pilot relay that automatically closes when the charger enters BOOST mode and opens when the charger reverts to FLOAT mode. The optional communications circuit board includes five discrete Form C contacts rated 2A at 30V AC or DC.

See the [Alarm Relays figure](#) and drawings at back of manual for relay details and location in charger. See the charger front door label for original factory alarm relay assignment code (see [Factory Configuration Information on Label](#)). See [Alarm Relay Contact Wiring](#) for assignment details. Alarm relay assignments are custom configurable using the SENS Setup Utility. Conduit knockouts are provided for alarm wires. Connect alarm wiring to alarm terminal blocks (see drawings at back of manual). See [Alarm Relay Contact Wiring](#) for typical alarm pin designations. The alarm wires should be connected from COM, through user supervisory system, then to either FAIL or OK. Wire from FAIL or OK to COM depending on whether the alarm should be present on an open or closed circuit (see [Alarm Relay Contact Wiring](#)). The optional alarm relay circuit board terminals accept 24-14 AWG (0.25-2.5 mm²) conductors. The optional communications circuit board terminals accept 28-16 AWG (0.08-1.5 mm²) conductors. Alarm and data interface wiring must be kept at least 1/4" (6.3mm) away from input conductors, output conductors, and from other uninsulated electrical parts not connected to the alarm or data conductor.

Alarm Relays

(case size Q2 with optional alarm relay and communications circuit boards shown)

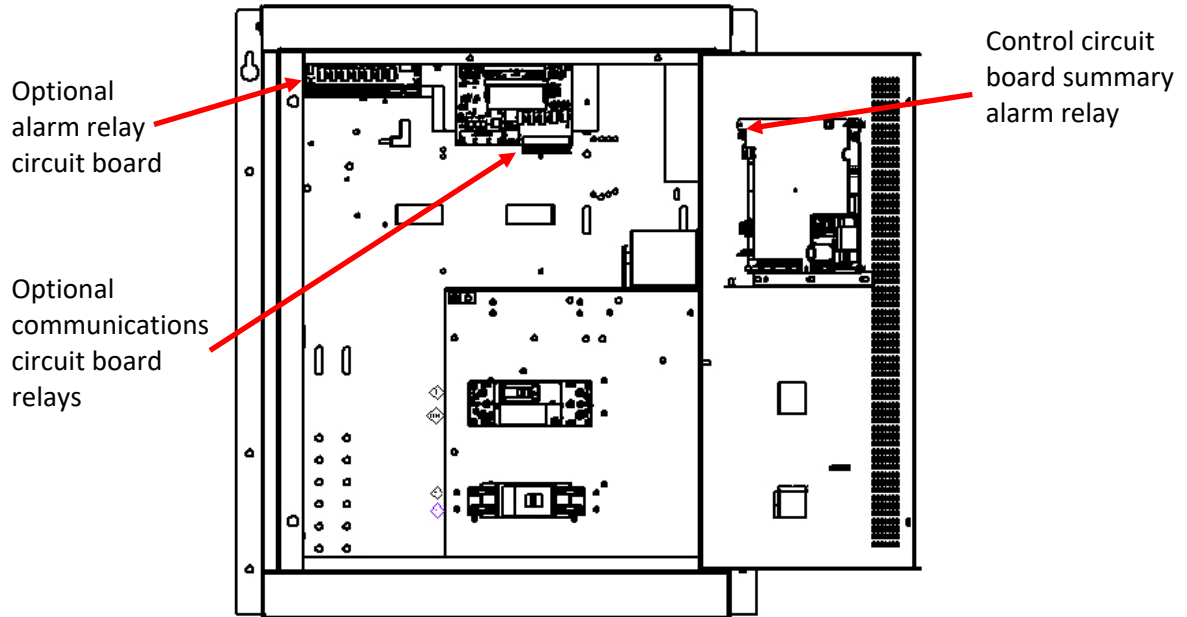

Factory Configuration Information on Label

SENS® LONGMONT, CO USA
 (303) 678-7500
 www.sens-usa.com

**STORED ENERGY SYSTEMS
 FILTERED BATTERY CHARGER**

MODEL: **Q024025PG514C** 2021 MAY 18
 SERIAL NO: **10182 20 21**
 MAC ADDRESS: **00-80-A3-C5-58-44**

AC INPUT:	120/208/240 VAC	50/60 Hz	1 Ø	12/6.7/5.8 AMPS
DC OUTPUT:	24 VDC (NOM)			25 AMPS

FLOAT: **133.08**VDC BOOST: **138.00**VDC BATT TYPE: **FLA**
 CONFIG CODE: **NGN** RLY CODE: **NGN-IQ**

UL US LISTED E117114 9929
CE

CAUTION:
 DO NOT INSTALL ON OR OVER COMBUSTIBLE SURFACES. DO NOT EXPOSE TO RAIN. CAPACITORS STORE HAZARDOUS ENERGY. DO NOT OPEN UNTIL 5 MINUTES AFTER DISCONNECTING ALL SOURCES. CHARGE ONLY LEAD ACID OR NICKEL CADMIUM BATTERIES. OTHER TYPES OF BATTERIES MAY BURST CAUSING PERSONAL INJURY AND DAMAGE.

PATENTED US 9,270,140; 9,385,556; 9,413,186; 9,509,164
 MADE IN U.S.A.

View output voltage, battery type and configuration code set at the factory

View alarm relay assignment code. See [Alarm Relay Contact Wiring for Stationary Power Configuration](#) for details.

Alarm Relay Contact Wiring for Stationary Power Configuration (code NGN-IQ)

Wire from COM to OK for alarm present on open circuit or from COM to FAIL for present on closed circuit.

	RELAY 1 Non-latching Coil	RELAY 2 Non-latching Coil	RELAY 3 Latching Coil	RELAY 4 Latching Coil	RELAY 5 Latching Coil	RELAY 6 Latching Coil	RELAY 7 Latching Coil	RELAY 8 Non-latching Coil
Relay Contacts	AC Fail	Charger Fail	Ground Fault	High DC	Low DC	End-of-Discharge	Battery Check Failure	Boost Mode Active
Common	COM (TB1-1)	COM (TB2-1)	COM (TB3-1)	COM (TB4-1)	COM (TB5-1)	COM (TB6-1)	COM (TB7-1)	COM (TB8-1)
Open on alarm	OK (TB1-2)	OK (TB2-2)	OK (TB3-2)	OK (TB4-2)	OK (TB5-2)	OK (TB6-2)	OK (TB7-2)	OK (TB8-2)
Close on alarm	FAIL (TB1-3) Defaults to FAIL with no AC and DC power (normally closed)	FAIL (TB2-3) Defaults to FAIL with no AC and DC power (normally closed)	FAIL (TB3-3)	FAIL (TB4-3)	FAIL (TB5-3)	FAIL (TB6-3)	FAIL (TB7-3)	FAIL (TB8-3) Defaults to FAIL with no AC and DC power (normally closed)

- A Summary alarm is located on the control circuit board and includes all alarms assigned to above relays.
- Chargers configured at the factory for genset applications (code GEN) include relay 1-5 assignments: Summary, AC Fail + Charger Fail, Low Crank, High DC, Low DC. Relays 6-8 assignable using SENS Setup Utility.
- Chargers configured at the factory for marine applications (code MAR) include relay 1-5 assignments: Summary, AC Fail + Charger Fail, Ground Fault, High DC, Low DC. Relays 6-8 assignable using SENS Setup Utility.

6.4. Operating Chargers in Parallel

It is highly recommended that for proper operation of two chargers connected in parallel to the same battery that one charger is connected to the second charger with a digital load sharing cable (see section [6.7](#) for further information). **The digital load sharing cable should never be connected when two chargers are each connected to different batteries.**

6.5. CANbus and RS-485 Connections—Optional

The unit is equipped with CANbus and RS-485 communications via two RJ-45 jacks when the optional communications circuit board is included (see [CANbus and RS-485 RJ-45 Connections](#)).

6.5.1. CANbus

The unit is equipped with CANbus communications support via the RJ45 ports. This interface is intended for communication with customer devices including battery monitoring systems, user interfaces, and customer-specific CAN protocol communications. Consult the factory for configuration and setup.

6.5.2. RS-485

The unit is equipped with serial RS-485 communications support via the RJ45 ports. This interface is intended for monitoring and communicating with the charger using protocols such as Modbus (optional) and DNP3 (optional). See manual sections on specific protocols for more information.

6.5.3. Connection

Connect communications using a twisted pair cable at the RJ-45 connector on the communications circuit board (see [CANbus and RS-485 RJ-45 Connections](#) and drawings at back of manual). Two RJ-45 ports are provided. The ports are in parallel and either port may be used. See the [Connector Pinout](#) for more information. Communications are isolated. An adapter from RJ-45

to an 8-position terminal block may be connected to the RJ-45 connector and is available to order separately (SENS p/n 208026, see [RJ-45 to Terminal Block Adapter](#) for more information).

CANbus and RS-485 RJ-45 Connections

(case size Q2 with optional alarm relay and communications circuit boards shown)

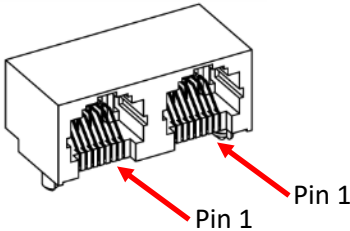
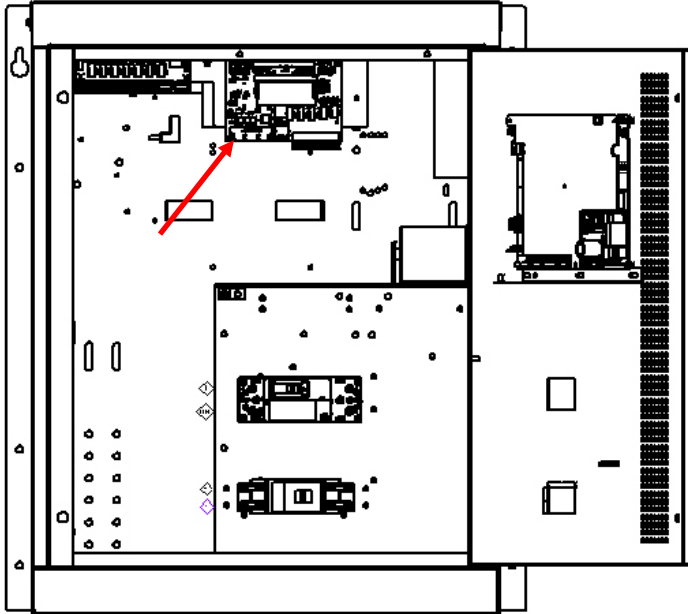

TWO PORTS:
Connect CANbus and/or Modbus to one or both ports

Connector Pinout

Pin #	Purpose
1	CANbus
2	CANbus
3	No connect pass-through
4	Modbus -D0 (B)
5	Modbus +D1 (A)
6	No connect pass-through
7	Power*
8	Common (isolated)

*Main circuit PCA only, used for interconnect between SENS devices

RJ-45 to Terminal Block Adapter — Optional

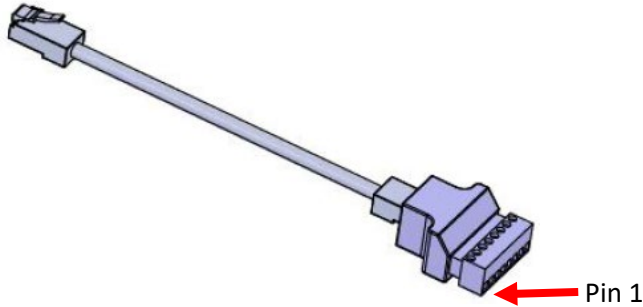

6.5.4. Termination

For proper operation, a 120-ohm terminator is required at the ends of the CAN and/or RS-485 bus. If multiple devices are on the bus, only the devices on the ends of the network bus need termination resistors. The [Typical RS-485 Termination figure](#) shows an example of how to terminate the network. Termination may be provided as part of the network cabling or 120-ohm termination plugs for the RJ-45 communications connector on the charger are available to order separately (SENS p/n 803707). SENS chargers are server devices. Pull-up and pull-down resistors are optional per Modbus specifications.

Typical RS-485 Termination

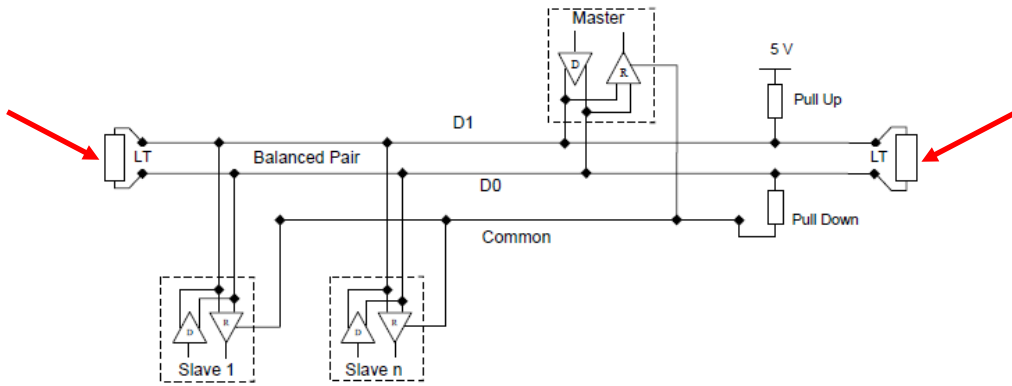

LT = Line Termination 120-ohm resistor

6.6. Ethernet—Optional

The unit is equipped with an ethernet RJ45 port when an optional communications circuit board is included (see [Ethernet Connection figure](#) and drawings at back of manual). Connect Cat5 or better ethernet cable. This provides a 10/100 ethernet connection. Modbus and DNP3 over TCP/IP communications are provided using the ethernet connection. Ethernet connectivity also provides communication to the charger for monitoring and configuration via the SENS Setup Utility when the optional protocol communications circuit board is included.

Ethernet Connection

(case size Q2 with optional alarm relay and communications circuit boards shown)

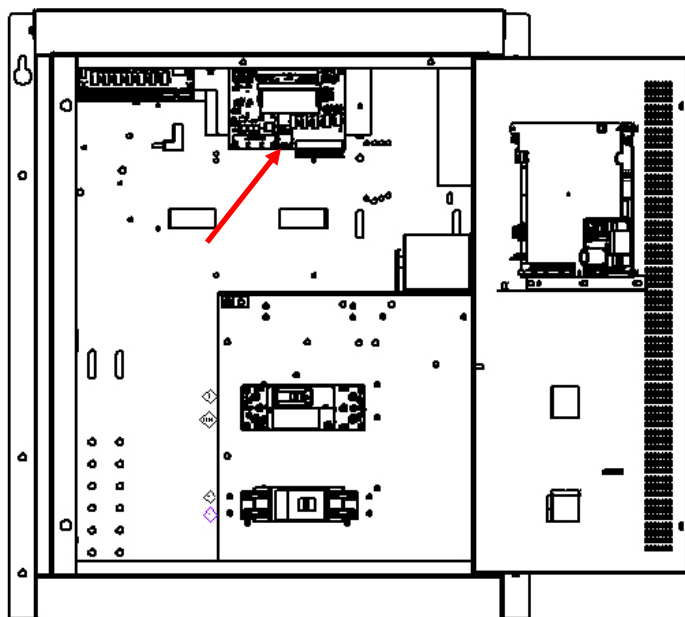

6.6.1. Configure TCP/IP Address

Configure TCP/IP settings using the SENS Setup Utility or the keypad (see section [9.9.3](#)). Set the IP address as desired. It may take up to 10 seconds for the network setting changes to apply. A TCP/IP address of 0.0.0.0 implies DHCP (Dynamic) addressing. Adjust the Gateway and Subnet Mask values as required. The displayed Hardware Address is the MAC address corresponding to the Ethernet interface. This value is not adjustable.

6.7. SENSbus Connection

The unit is equipped with a SENSbus RJ45 port on the control circuit board to interconnect SENS specific devices (see [SENSbus Connection figure](#) and drawings at back of manual).

**|| WARNING:
DO NOT PLUG ETHERNET INTO THIS CONNECTION**

A remote accessory may be connected to multiple chargers. In this case, the remote accessory, chargers or other equipment may be located at the ends of the communications bus. Ensure a terminator is located at both ends of the communications bus.

SENSbus Connection

(case size Q2 with optional alarm relay and communications circuit boards shown)

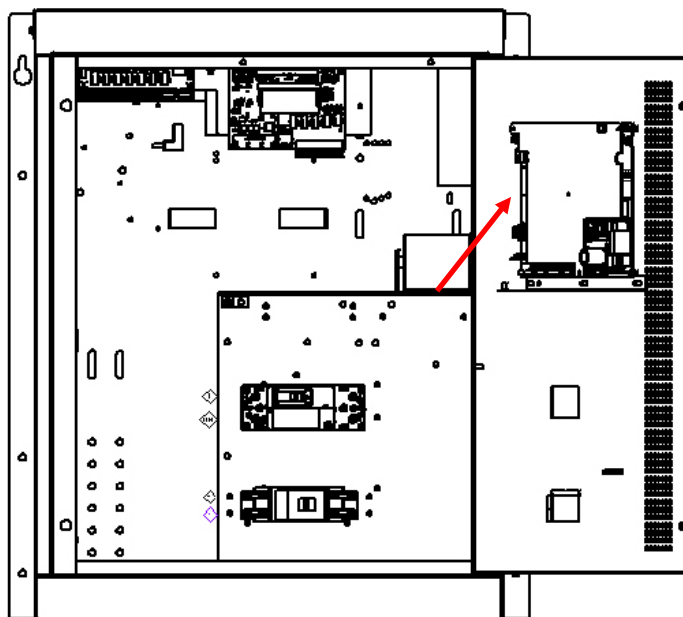

6.7.1. Load Share Connection—Optional

Multiple chargers may be connected in parallel to provide charger redundancy and increased charging current using a load sharing accessory, available to order separately (SENS p/n 209069). Connect the load sharing accessory from one charger to another using the SENSbus RJ-45 port on the control circuit board of each charger to automatically initiate load sharing (see [SENSbus Connection](#)). Connect one charger to the “CHARGER 1” port and the other charger to the “CHARGER 2” port on the load sharing accessory using provided network cables. Connect the other end of the network cables to the SENSbus RJ-45 port on each charger. Leave a factory installed 120-ohm terminator in a SENSbus port on each charger to ensure a terminator is located at both ends of the communications bus. The terminator may be located in the SENSbus port on the optional relay or communications boards rather than the control circuit board when the optional boards are included.

Load sharing is essential to synchronizing operation of the Dynamic Boost and HELIX modes and helps ensure that current is shared within $\pm 10\%$ between chargers. Chargers intended for load sharing must be configured with the same output settings in order to load share. No additional user setup is required to enable active current sharing. Two or more chargers automatically negotiate with each other to determine which charger is designated as the master unit.

6.7.2. Remote Battery Monitor—Optional

The optional remote battery monitor accessory provides the ability to monitor battery temperature and ambient temperature. Future options include battery voltage, battery current, battery float current, 5V logic inputs and other parameters.

Connect the remote battery monitor to the charger using a network cable connected to the SENSbus RJ-45 port. Remove a factory installed 120-ohm terminator from the SENSbus RJ-45 port to connect the network cable from the remote battery monitor. Ensure a terminator remains in another SENSbus RJ-45 port on the charger. Place a 120-ohm terminator in the open RJ-45 SENSbus port on the remote battery monitor to ensure a terminator is located at both ends of the communications bus.

6.7.3. **Remote Alarm/Communications Panel Accessory Connection—Optional**

The optional remote alarm/communications panel accessory provides the ability to adjust and communicate with multiple chargers using one external device. The remote panel accessory may be configured with different alarm relay assignments than the alarm relays native to the charger.

Remove a factory installed 120-ohm terminator from the SENSbus RJ-45 port on the charger to connect the network cable from the remote panel. Ensure a terminator remains in another SENSbus RJ-45 port on the charger. Connect a straight-thru splitter to the RJ-45 SENSbus port on the remote panel. Place a 120-ohm terminator in one of the positions on the remote panel splitter to ensure a terminator is located at both ends of the communications bus. Connect the remote panel to the charger using a network cable from the SENSbus RJ-45 port on the charger to the remote panel splitter.

6.8. **Remote Temperature Sensor Connection—Optional**

The charger includes local temperature compensation using an internal sensor. Alternately, the charger will use remote temperature compensation based on the temperature of the batteries when an optional external sensor is located at the batteries and connected to the control circuit board remote temperature sensor terminal block (see Remote Temp Sense Connection figure below). Remote temperature compensation is highly recommended in all applications. It is most critical in applications where battery and charger are located in different ambient conditions. Chargers connected to load share only require a remote temperature sensor connected to one charger. Temperature compensation is disabled by setting the temperature compensation slope to zero using the keypad or SENS Setup Utility. See section 9.11 for further information regarding temperature compensation. A 50-foot remote temperature sensor is available to order separately (SENS p/n 209481).

The remote temperature sensor is not polarized; it does not matter which lead connects to each terminal. Route sensor wiring at least ¼ inch (6 mm) away from DC wiring, AC wiring, and the circuit board. Locate the remote sensor where it will accurately detect the battery temperature by connecting it to a *grounded* battery terminal or the battery case. When securing to the battery case, use an adhesive/glue properly rated for the application material and temperature, such as Super Glue®.

Remote Temp Sense Connection
(case size Q2 with optional alarm relay and communications circuit boards shown)

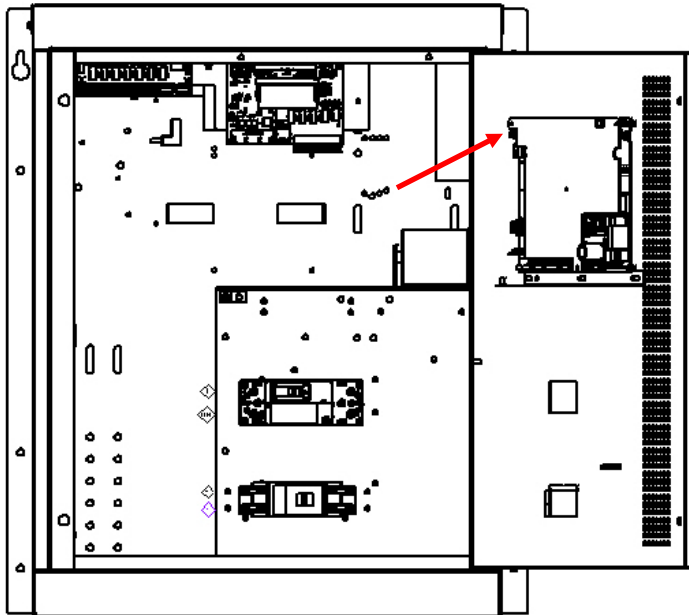

6.9. USB Connection

The unit is equipped with a Micro-USB port on the control circuit board (see USB Connection figure below). USB communication provides connectivity to the charger for configuration via the SENS Setup Utility. Charger may also be connected to the SENS Setup Utility using ethernet (see section [6.6](#)).

USB Connection

(case size Q2 with optional alarm relay and communications circuit boards shown)

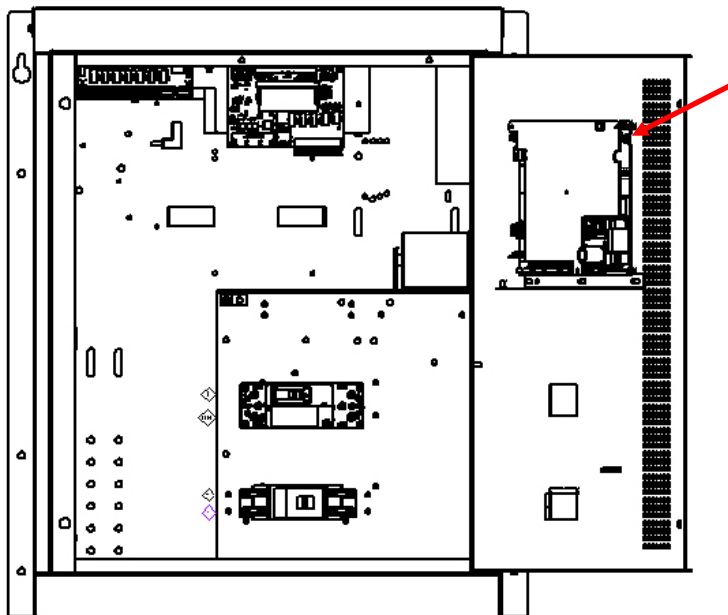

7 POWER ON/POWER OFF PROCEDURES

7.1. Verify Input AC Supply

With the input AC and output DC breakers open, connect a portable voltmeter to the line side of the input AC breaker on the charger. Energize the AC supply at main electrical panel and verify it is within acceptable range.

7.1.1. Verify Nominal AC

For dual and triple input models (input codes, P, T and Z), verify the correct nominal AC input voltage is set in the “Nominal Volts AC” front panel menu and on the selection jumper/terminal block inside the charger. See section 2 for details.

7.2. Output/Battery Voltage

With the input AC and output DC breakers open, connect a portable voltmeter to the load side of the DC breaker and verify that battery voltage (for applications with batteries) is within acceptable range of the charger output voltage setting. Charger output voltage setting is displayed on the front door label (see [Factory Configuration Information](#)).

7.3. Verify Charger Output

Connect a portable voltmeter to the line side of the charger DC output circuit breaker. With the charger DC output circuit breaker still open, close the charger AC input circuit breaker and verify that charger output comes up to its nominal float setting. It should take less than 30 seconds for the charger output to reach its final value.

7.4. Verify Configuration

Refer to the label on the charger front door for factory configured output voltage, battery type and configuration code (see [Factory Configuration Information](#)). Review and adjust charger configuration using

the front panel keypad or the SENS Setup Utility if factory configured settings require modification. See section [9.9.3](#) for additional details on keypad navigation.

7.4.1. Battery Types

Adjusting battery types using the front panel keypad requires advanced security access. Navigate to the “User Access” menu area to ensure the keypad access level is set to allow adjustments.

7.4.1.1. FLA

This setting is ideal for flooded lead-acid batteries. The charging algorithm options for flooded lead-acid batteries includes Float mode (see section [9.2](#)), Dynamic Boost™ mode (see section [9.3](#)) and HELIX mode (for genset applications only, see section [9.4](#)).

7.4.1.2. AGM

The term, “AGM” in this manual and for the charger refers to AGM (absorbed glass mat) type batteries that are employed in engine starting applications. This charging mode should not be used with switchgear or other industrial type batteries. For AGM type batteries employed in switchgear or other industrial applications please see the “VRLA” battery type below.

7.4.1.3. NICD

This setting is appropriate when using nickel-cadmium batteries. The charging algorithm for nickel-cadmium batteries includes Float mode (see section [9.2](#)) and Dynamic Boost™ mode (see section [9.3](#)). Nickel-cadmium batteries are used in all applications.

7.4.1.4. VRLA

The “VRLA” battery profile includes all valve regulated batteries, including AGM types, which are employed in switchgear and other industrial applications. The charging algorithm for valve-regulated lead-acid batteries includes Float mode only (see section [9.2](#)).

7.4.2. Configuration Code

The Configuration Code indicates charging algorithm and alarm setpoints configured at the factory. See sections 8 and 9 for further information. Configuration types include:

7.4.2.1. Industrial / Utility (NGN)

This configuration code is intended for standard industrial and utility applications and is the typical factory-supplied configuration code for EnerGenius IQ.

7.4.2.2. GENSET (GEN)

This configuration code is intended for standard engine start applications.

7.4.2.3. MARINE (MAR)

This configuration code is intended for standard marine applications.

7.4.2.4. Power Supply (PSP)

This configuration code is intended for standard power supply applications where a storage battery is not connected.

7.5. Begin Charging

Close the DC output breaker. Depending on the state of charge of the batteries and the load on the DC bus, the charger may go into current limit at this time, in which case the output voltage as displayed on the LCD will be reduced as the charger operates in constant current mode. Eventually as the battery is charged, the charging current demand should taper to a value below the current limit set point of the charger, and the charger should revert to constant voltage output, regulating the DC bus at the float level.

7.6. Power Off

Power off the charger by opening the AC and DC breakers, in any order.

8 ALARMS, LEDS AND DISPLAY

8.1. Front Panel User Interface

The front panel user interface provides information about input, output, charging status and alarms and allows configuration using the keypad. The front panel user interface is shown below in the Front Panel User Interface figure. Press the Enter to save a setting or move backward within the user interface menus (see section 9.9.3 for menu options).

NOTE:

With no AC mains supply present and with a battery connected to the output of the charger, and with the DC output breaker closed, the display will operate. Battery voltage and alarm status will be displayed. With the system in this condition, charger models without the optional blocking diode use the following power from the battery.

Output Voltage	Max Quiescent Power Consumption
12V	6W
24V	18W
48V	22W
120V	35W
240V	64W

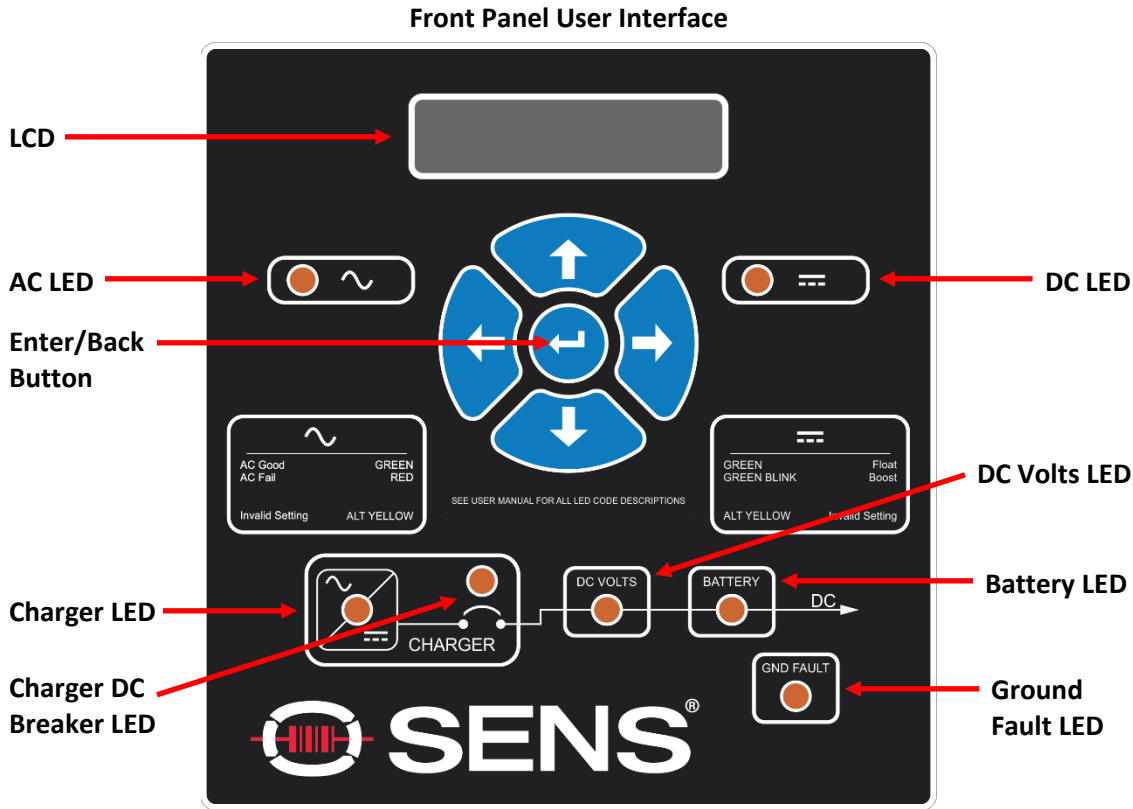

8.2. LCD Panel

A two line by twenty-character LCD is included with every charger and provides precision digital AC and DC ammeters and voltmeters as well as information about input, output, charging status and alarms. The voltmeters are accurate to $\pm 1\%$ and the ammeters are accurate to $\pm 1\%$. The display is readable with or without ambient lighting and operates automatically, requiring no operator intervention.

The LCD is fully operational from -20°C to +50°C. It may temporarily become unreadable below -20°C but should recover as temperature increases. LCD life is reduced with sustained operation above 50°C.

8.3. AC and DC LED Indicators

The charger is equipped with two primary LEDs, one for AC status and one for DC status. See further alarm definitions in section [8.7](#). LEDs and the front panel LCD will indicate the alarm(s).

LED Definitions

AC LED	DC LED	Meaning
OFF	OFF	AC and DC not applied or charger failed or alarm/communications circuit board cannot communicate with main circuit board
SOLID GREEN	SOLID GREEN	AC good, DC good, in Float Mode
SOLID GREEN	FLASHING GREEN	AC good, in Boost Mode
SOLID GREEN	FLASHING 2X GREEN	AC good, DC in current limit (max charge)
SOLID GREEN	FLASH LONG-SHORT GREEN	AC good, HELIX Eco-Float mode
SOLID GREEN	FLASH LONG-2X SHORT GREEN	AC good, HELIX Refresh Charge mode
SOLID GREEN	FLASH LONG-SHORT YELLOW	AC good, battery commissioning mode active
SOLID GREEN	FAST FLASHING GREEN	AC good, battery check in progress
SOLID GREEN	FAST FLASHING YELLOW	AC good, battery check failure
SOLID GREEN	SOLID RED	AC good, charger fail or overvoltage shutdown (charger disabled)
SOLID GREEN	FLASHING RED/YELLOW	AC good, reverse polarity detected on output
SOLID GREEN	SOLID YELLOW	AC good, high or low DC voltage (above/below alarm setpoint)
SOLID GREEN	FLASHING GREEN/RED	AC good, system DC output good, some individual charger module(s) in alarm state
SOLID GREEN	FLASHING RED/YELLOW	AC good, incompatible battery (charger disabled)
SOLID GREEN	FLASHING YELLOW	AC good, positive/negative ground fault present
SOLID GREEN	FLASHING GREEN/YELLOW	AC good, output limited by high temperature
SOLID GREEN	DOUBLE FLASH YELLOW	AC good, load share fail
SOLID GREEN	DOUBLE FLASH RED	AC good, load sharing DC negative connection open or load sharing charger address fault
SOLID YELLOW	SOLID GREEN	AC voltage/frequency out of range or AC phase missing, DC voltage good
SOLID RED	SOLID GREEN	AC fail or over max voltage, DC voltage good
SOLID RED	SOLID YELLOW	AC fail, high or low DC voltage (above/below alarm setpoint)
SOLID RED	SOLID RED	AC fail, charger fail or overvoltage shutdown (charger disabled)
SOLID RED	FLASHING RED/YELLOW	AC fail, incompatible battery (charger disabled)
SOLID RED	FLASHING YELLOW	AC fail, positive/negative ground fault present
	FLASH LONG-2X SHORT YELLOW	SENSbus Inactive
	ALTERNATING FLASHING YELLOW	Invalid Settings
	ALTERNATING FLASHING RED	Missing or invalid code (boot load required)
	ALTERNATING FLASHING GREEN	Charger starting up

8.4. Mimic Panel LEDs

In addition to the primary AC and DC LEDs, the charger is equipped with mimic panel status LEDs. LEDs and the front panel LCD will indicate the alarm(s).

8.4.1. Charger LED

Indicates charger status. Green indicates a normally operating charger, flashing yellow indicates an incompatible battery is connected, flashing green/yellow indicates a charger Thermal Foldback warning, red indicates an Over Voltage Shutdown or Charger Failure alarm.

8.4.2. Charger DC Breaker LED

Indicates DC breaker status. Green indicates DC breaker is closed and red indicates DC breaker is open. Amber indicates charger cannot determine if breaker is open or closed.

8.4.3. DC Volts LED

Indicates DC output voltage status. Green indicates DC voltage is normal, yellow indicates a low or high battery condition, red indicates an Over Voltage Shutdown or Charger Failure alarm.

8.4.4. Battery LED

Indicates battery status. Solid green indicates a passed Battery Check, flashing green indicates a Battery Check in progress, flashing yellow indicates a failed Battery Check, solid yellow indicates a High Battery Temperature alarm, red indicates a High Battery Temperature Shutdown alarm (charger output disabled). A blank LED indicates a Battery Check test has not occurred, the Battery Check feature is disabled, or the battery type or cell count has changed.

8.4.5. Ground Fault LED

Indicates a Ground Fault alarm. Solid yellow indicates a positive ground fault alarm and flashing yellow indicates a negative ground fault alarm. Solid green indicates ground fault current is below alarm threshold. A blank LED indicates ground fault alarm is disabled.

8.5. Individual Alarm Relay Contacts

The control and optional alarm/communications circuit boards include discrete Form C contacts. The Form C relay contacts change state when alarms are activated. Alarm relay assignments are custom configurable to any of the alarm functions listed in section [8.7](#). See charger door label for original factory alarm relay assignments. See the [Alarm Relay Contact Wiring](#) for typical alarm relay assignments. The relays can be configured to be latching or non-latching with adjustable delays using the SENS Setup Utility. By default, the relay contacts change state 30 seconds after the onset of a fault.

8.6. Latched Alarms

All alarm messages displayed on the front panel LCD are latching. Alarm relay configurations created using the SENS Setup Utility may be configured as latching if desired. Once an alarm condition no longer exists, the alarm message will no longer display in the main/home screen but will remain under the “Latched Alarms” menu. Clear latched alarms using the keypad under the “Latched Alarms” menu (see section [9.9.3](#)), using the SENS Setup Utility or by cycling power.

8.7. Alarm Definitions

See [LED Definitions](#) for a description of LED indicator activity. Unless noted otherwise, the following alarms are displayed on the LCD panel.

8.7.1. AC Line Failure

Indicates AC input voltage is not detected or is outside of the allowed range. Activates solid red AC LED. When this alarm is assigned to a relay contact AC LINE FAIL will cause the assigned relay to change to the Failed state after the time delay.

8.7.2. High DC Voltage

Indicates DC output voltage is above the High DC Voltage factory alarm setpoint (see table below) or the configured level if setpoint is adjusted using keypad or SENS Setup Utility. Activates solid yellow DC LED. When this alarm is assigned to a relay contact HIGH DC VOLTAGE will cause the assigned relay to change to the Failed state after the time delay.

Factory High DC Setpoints

Configuration Code*	Battery Type	High DC Setpoint (V / Cell)
GEN	AGM	2.667
	FLA	2.667
	NICD	1.600
	HCB	2.667
MAR	VRLA	2.440
	AGM/FLA	2.470
	NICD	1.600
NGN	VRLA	2.440
	AGM/FLA	2.470
	NICD	1.600
PSP	N/A	2.200

*Configuration Code displayed on charger label

8.7.3. Battery on Discharge

Indicates battery is beginning to discharge and DC output voltage is below Battery Discharge Voltage factory alarm setpoint (see table below) or the configured level if setpoint is adjusted using keypad or SENS Setup Utility. The BATTERY DISCHARGING alarm is the first to trigger of three low output voltage alarms and is followed by LOW DC and then END OF DISCHARGE. Alarm setpoint must be set higher than LOW DC and END OF DISCHARGE alarms. Activates solid yellow DC LED. When this alarm is assigned to a relay contact BATTERY DISCHARGING will cause the assigned relay to change to the Failed state after the time delay.

Factory Battery Discharging Setpoints

Configuration Code*	Battery Type	Battery Discharging Setpoint (V / Cell)
GEN	AGM	2.083
	FLA	2.083
	NICD	1.250
	HCB	2.083
MAR	VRLA	2.000
	AGM/FLA	2.000
	NICD	1.200
NGN	VRLA	2.000
	AGM/FLA	2.000
	NICD	1.200
PSP	N/A	1.700

*Configuration Code displayed on charger label

8.7.4. Low DC Voltage

Indicates battery has discharged and DC output voltage is below Low DC Voltage factory alarm setpoint (see table below) or the configured level if setpoint is adjusted using keypad or SENS Setup Utility. Alarm setpoint must be set lower than BATTERY DISCHARGING and higher than END OF DISCHARGE alarms. Activates solid yellow DC LED. When this alarm is assigned to a relay contact LOW DC VOLTAGE will cause the assigned relay to change to the Failed state after the time delay.

Factory Low DC Setpoints

Configuration Code*	Battery Type	Low DC Setpoint (V / Cell)
GEN	AGM	2.017
	FLA	2.017
	NICD	1.210
	HCB	2.017
MAR	VRLA	1.833
	AGM/FLA	1.833
	NICD	1.100
NGN	VRLA	1.833
	AGM/FLA	1.833
	NICD	1.100
PSP	N/A	1.700

*Configuration Code displayed on charger label.

8.7.5. Battery End of Discharge

Indicates DC output voltage is below Battery End Discharge factory alarm setpoint (see table below) or the configured level if setpoint is adjusted using keypad or SENS Setup Utility. This alarm is intended only for longer discharge rates (i.e. not engine starting applications) and indicates the normal end-of-discharge voltage for a lead-acid battery. Alarm setpoint must be set lower than LOW DC and BATTERY DISCHARGING alarms. Activates solid yellow DC LED. When this alarm is assigned to a relay contact BATTERY END OF DISCHARGE will cause the assigned relay to change to the Failed state after the time delay.

Factory Battery End of Discharge Setpoints

Configuration Code*	Battery Type	Battery End of Discharge Setpoints (V / Cell)
GEN	AGM	1.750
	FLA	1.750
	NICD	1.050
	HCB	1.750
MAR	VRLA	1.750
	AGM/FLA	1.750
	NICD	1.050
NGN	VRLA	1.750
	AGM/FLA	1.750
	NICD	1.050
PSP	N/A	1.700

*Configuration Code displayed on charger label.

8.7.6. Charger Failure

Indicates the charger is not able to provide the current demanded by the battery and/or load or is providing more current than the charger’s control system is commanding. This alarm is typically caused by an internal component failure. This alarm does not occur during AC power failures. Activates solid red DC LED. When this alarm is assigned to a relay contact CHARGER FAIL will cause the assigned relay to change to the Failed state after the time delay.

8.7.7. Over Voltage Shutdown

Indicates that the charger has executed a high voltage shutdown and DC output voltage is above Over Voltage Shutdown factory alarm setpoint (see table below) or the configured level if setpoint is adjusted using keypad or SENS Setup Utility. The charger disables itself whenever excessive output voltage occurs while the charger is delivering current. The overvoltage shutdown system is protected against nuisance trips and will not execute if the high voltage condition is caused by an external source including a parallel connected charger of any type. Activates solid red DC LED. When this alarm is assigned to a relay contact OVERVOLTAGE SHUTDOWN will cause the assigned relay to change to the Failed state after the time delay.

Factory Overvoltage Shutdown Setpoints

Configuration Code*	Battery Type	Overvoltage Shutdown Setpoint (V / Cell)
GEN	AGM	2.834
	FLA	2.834
	NICD	1.700
	HCB	2.834
MAR	VRLA	2.530
	AGM/FLA	2.568
	NICD	1.700
NGN	VRLA	2.530
	AGM/FLA	2.568
	NICD	1.700
PSP	N/A	2.200

*Configuration Code displayed on charger label.

8.7.8. Reverse Polarity

Indicates battery is connected backwards. Charger output is disabled until the condition is corrected. Activates flashing red/yellow DC LED. When this alarm is assigned to a relay contact REVERSE POLARITY will cause the assigned relay to change to the Failed state after the time delay.

8.7.9. Low Cranking Voltage

Indicates the battery voltage is likely to be inadequate to provide engine-cranking capability. Indicates that DC output voltage during a prior cranking event dropped below default setpoint (2 volts/cell). **This alarm is latching and must be manually reset by disconnecting both AC and DC power or using keypad.** Chargers intended for marine and standby power applications are shipped with the low cranking voltage alarm disabled. Alarm/communications circuit board LOW CRANK relay contacts change to Fail state after delay when alarm is assigned to relay contacts.

8.7.10. Incompatible Battery

Indicates charger is connected to an incompatible battery. The charger operates for approximately 5 minutes while observing behavior of the DC voltage. If DC voltage behavior is normal the charger will continue charging. If DC voltage behavior is abnormal, as is typical with a battery voltage mismatch, the charger will shut down and lock off after approximately five minutes. Activates flashing yellow DC LED. When this alarm is assigned to a relay contact INCOMPATIBLE BATTERY will cause the assigned relay to change to the Failed state after the time

delay. After correcting mismatched condition cycle power to reset the charger and begin operation. See section [9.5](#) for charging a very low or zero-volt battery, when this safety feature would be a nuisance.

8.7.11. Invalid Settings

Indicates settings are not valid. Output is disabled until the condition is corrected. Activates alternating flashing yellow AC and DC LEDs. When this alarm is assigned to a relay contact INVALID SETTINGS will cause the assigned relay to change to the Failed state after the time delay.

8.7.12. SENSbus Inactive

Indicates the charger is not communicating on SENSbus either when load sharing and/or remote accessories are connected. Activates flashing long then 2x short yellow AC and DC LEDs. When this alarm is assigned to a relay contact SENSBUS INACTIVE will cause the assigned relay to change to the Failed state after the time delay.

8.7.13. Thermal Fold Back

Indicates output power has been reduced to protect from over-heating. The charger will not be able to produce full output until the ambient temperature is lowered. When this alarm is assigned to a relay contact THERMAL FOLDBACK will cause the assigned relay to change to the Failed state after the time delay.

8.7.14. No Remote Temp Sense

Indicates disabled or failed remote temperature sensor. When the temperature probe sensor is shorted temperature compensation is turned OFF. When this alarm is assigned to a relay contact TEMPERATURE PROBE FAULT will cause the assigned relay to change to the Failed state after the time delay.

8.7.15. Current Limiting

Indicates the charger is operating at the maximum current setting. Activates flashing green DC LED. When this alarm is assigned to a relay contact CURRENT LIMITING will cause the assigned relay to change to the Failed state after the time delay.

8.7.16. Ground Fault Positive or Ground Fault Negative

Indicates a short circuit or high impedance leakage current exists from the charger positive/negative to ground. Chargers intended for Marine and Utility/Industrial applications are shipped with this alarm enabled and set to 500 μ A by default. Ground fault settings can be adjusted using the front panel keypad or the SENS Setup Utility. The sensitivity adjustment range is from 0 (OFF) to the maximum specified below in 100 μ A increments. A Setup Error code will alert users if this is adjusted beyond the charger capability.

Rated DC Voltage	Max Ground Fault Setpoint
12VDC	1200 μ A
24VDC or 120VDC	2500 μ A
48VDC or 240VDC	5000 μ A

Activates flashing yellow DC LED. When this alarm is assigned to a relay contact GROUND FAULT POSITIVE or GROUND FAULT NEGATIVE will cause the assigned relay to change to the Failed state after the time delay. Using the keypad, navigate to the "DC Meters" menu to view detected ground fault voltage and current.

A positive ground fault alarm may occur when a load sharing charger is equipped with output blocking diodes (last numeric character in charger model number is "3" or "4") and the charger is disabled (AC failure, etc.) while the DC output circuit breaker is closed. The blocking diode disconnects the negative output terminal from the charger's ground fault sensing bridge, while the positive output remains connected. This asymmetry causes a weak ground fault current to flow in the positive output, which the *other* charger detects, causing a ground fault indication. To

avoid this alarm, reduce the ground fault sensitivity setting or disable ground fault detection. The ground current is real and can be detected by more sensitive ground fault thresholds.

8.7.17. **Low Current**

Indicates current from the charger is below the Low Current Alarm setpoint. Unless specified by customer order, chargers are shipped with the low current alarm disabled. When this alarm is assigned to a relay contact LOW CURRENT will cause the assigned relay to change to the Failed state after the time delay.

8.7.18. **Load Share Fail**

Indicates that chargers connected for load sharing are not sharing the current load. Activates double flashing yellow DC LED. When this alarm is assigned to a relay contact LOAD SHARE FAIL will cause the assigned relay to change to the Failed state after the time delay.

8.7.19. **AutoBoost Lockout Active**

Indicates the Boost mode time limit has expired and charger has returned to Float mode. Boost mode is disabled until the time limit is reset. The Boost time limit is reset if charger power is cycled. The Boost time limit is set to 24 hours by default. When this alarm is assigned to a relay contact AUTOBOOST LOCKOUT ACTIVE will cause the assigned relay to change to the Failed state after the time delay.

8.7.20. **DC Below Startup Voltage**

Indicates battery voltage is below the factory Startup Voltage setpoint or the configured level if setpoint is adjusted using keypad or SENS Setup Utility. When this alarm is assigned to a relay contact DC BELOW STARTUP VOLTAGE will cause the assigned relay to change to the Failed state after the time delay.

8.7.21. **Battery Check**

Indicates battery has failed the most recent battery check. This is a latching alarm. This alarm is cleared by passing a new battery check or by manual reset. When this alarm is assigned to a relay contact BATTERY CHECK will cause the assigned relay to change to the Failed state after the time delay.

8.7.22. **Thermal Fault**

Indicates charger has faulted because it over heated and thermal fold-back has reached zero watts. Charger output has been disabled. Cycle AC and DC power for re-initiation. When this alarm is assigned to a relay contact THERMAL FAULT will cause the assigned relay to change to the Failed state after the time delay.

8.7.23. **High Battery Temperature**

Indicates battery temperature is above the High Battery Temperature setpoint. This alarm is only available when a remote battery temperature sensor is installed (with or without the optional remote battery monitor). When this alarm is assigned to a relay contact HIGH BATTERY TEMPERATURE will cause the assigned relay to change to the Failed state after the time delay.

8.7.24. **High Battery Temperature Shutdown**

Indicates battery temperature is above the High Battery Temperature Shutdown setpoint and that the charger has shut off as a safety concern. This alarm is only available when a remote battery temperature sensor is installed (with or without the optional remote battery monitor). When this alarm is assigned to a relay contact HIGH BATTERY TEMPERATURE SHUTDOWN will cause the assigned relay to change to the Failed state after the time delay.

8.7.25. **High Battery Room Temperature**

Indicates battery room temperature is above the High Battery Room Temperature setpoint. This alarm is only available with the optional remote battery monitor. When this alarm is assigned to a

relay contact HIGH BATTERY ROOM TEMPERATURE will cause the assigned relay to change to the Failed state after the time delay.

8.7.26. **Charger Low Temperature**

Indicates charger is currently below its rated temperature. Output may be derated. When this alarm is assigned to a relay contact CHARGER LOW TEMPERATURE will cause the assigned relay to change to the Failed state after the time delay.

8.7.27. **Battery Low Temperature**

Indicates battery temperature is below the Low Battery Temperature setpoint. This alarm is only available when a remote battery temperature sensor is installed (with or without the optional remote battery monitor). When this alarm is assigned to a relay contact BATTERY LOW TEMPERATURE will cause the assigned relay to change to the Failed state after the time delay.

8.7.28. **AC Voltage Over Maximum**

Indicates AC Voltage has gone above maximum allowed by the charger. This alarm has a delay of 3 seconds. Output has been disabled. Activates solid red AC LED. When this alarm is assigned to a relay contact AC VOLTAGE OVER MAXIMUM will cause the assigned relay to change to the Failed state after the time delay.

8.7.29. **AC Voltage Low**

Indicates AC Voltage has gone below AC Min Voltage alarm setpoint. Activates solid yellow AC LED. When this alarm is assigned to a relay contact AC VOLTAGE LOW will cause the assigned relay to change to the Failed state after the time delay.

8.7.30. **AC Frequency Out of Range**

Indicates AC Frequency is above the AC High Frequency or below the AC Low Frequency alarm setpoint. Activates solid yellow AC LED. When this alarm is assigned to a relay contact AC FREQUENCY OUT OF RANGE will cause the assigned relay to change to the Failed state after the time delay.

8.7.31. **AC Voltage High**

Indicates AC Voltage is above the AC Max Voltage alarm setpoint. Activates solid yellow AC LED. When this alarm is assigned to a relay contact AC VOLTAGE HIGH will cause the assigned relay to change to the Failed state after the time delay.

8.7.32. **DC Breaker**

Indicates that DC breaker is OPEN or has tripped. Only active with Breaker Status option. Alarm/communications circuit board DC BREAKER relay contacts change to Fail state after delay when alarm is assigned to relay contacts.

8.7.33. **TCP/IP Error**

Indicates a setup error on the Modbus TCP/IP device on the optional communications circuit board. Re-apply network settings using the front panel keypad by re-entering the IP address and then pressing the Enter (center arrow) key.

9 OPERATION

9.1. Charging Algorithms

The charger uses charging algorithms appropriate for different battery types. The charging algorithm for each battery type includes various combinations of Float mode, Dynamic Boost™ mode, and HELIX mode, as described in the Charging Algorithms table below. See following sections for descriptions of each charging mode.

Charging Algorithms

Battery Type	Charging Algorithm		
	Float Mode	Dynamic Boost Mode	HELIX Mode
FLA	✓	✓	
FLA for genset	✓	✓	✓
NICD	✓	✓	
VRLA	✓		

9.1.1. Recharging Batteries

After a battery has been discharged, the charger will enter Dynamic Boost mode if this mode is enabled (see section [9.3](#)). The charger's output voltage setpoint during Dynamic Boost mode increases to the boost voltage value (see section [9.3](#)). If the battery is deeply discharged, DC voltage will remain below the boost voltage setpoint until the charger's output current drops below its rated maximum. Charging in the boost mode continues until the Dynamic Boost control system ends the boost mode or the boost time limit expires (boost time limit set to 24 hours by default). After operating in boost mode the charger switches to Float mode (see section [9.2](#)). If HELIX mode is enabled the charger will enter HELIX mode after operating in Float for a short time.

9.2. Float Mode

Float mode is used to maintain stationary batteries in a fully charged state. When the charger is in Float mode the output voltage is maintained at the float voltage setting. See door label for original factory configuration float value.

Factory Float Voltage Settings

Configuration Code*	Battery Type	Float Voltage (V / Cell)
GEN	AGM	2.27
	FLA	2.22
	NICD	1.43
	HCB	2.23
MAR	VRLA	2.27
	AGM/FLA	2.22
	NICD	1.43
NGN	VRLA	2.27
	AGM/FLA	2.22
	NICD	1.43
PSP	N/A	2.00

*Configuration Code displayed on charger label.

9.3. Dynamic Boost™ Mode

Dynamic Boost is an advanced method of boost charging that automatically computes during each recharge the optimal time for the charger to remain at the boost voltage, before transitioning back to the float charge mode. Dynamic Boost automatically adjusts for differing battery sizes, depths of discharge, varying

load, battery age and other variables. Dynamic Boost mode safely maximizes recharge performance while cutting risks of both overcharging and undercharging associated with manual or automatic boost timers or earlier generation automatic boost control systems.

Dynamic Boost is automatically used by the charger depending on battery type selected. See door label for original factory configuration boost value. Flooded lead-acid and nickel-cadmium batteries are automatically charged using Dynamic Boost mode when the battery requires it. Charging in boost mode continues until the Dynamic Boost control system ends boost mode or the boost time limit expires. The boost time limit is set to 24 hours by default. Since boost charging is discouraged by most manufacturers of valve-regulated lead-acid (VRLA) batteries used in stationary applications Dynamic Boost mode is disabled when the charger battery type is VRLA. The above descriptions are the default values, and Dynamic Boost can be enabled or disabled by the user at any time.

Configure the charger appropriately using the keypad or SENS Setup Utility. Use of the optional remote temperature compensation sensor is highly recommended to maximize charging performance and optimize battery life.

Factory Boost Voltage Settings

Configuration Code*	Battery Type	Boost Voltage (V / Cell)
GEN	AGM	2.39
	FLA	2.36
	NICD	1.52
	HCB	2.40
MAR	VRLA	Disabled
	AGM/FLA	2.30
	NICD	1.52
NGN	VRLA	Disabled
	AGM/FLA	2.30
	NICD	1.52
PSP	N/A	Disabled

*Configuration Code displayed on charger label.

9.4. HELIX Mode

HELIX (High Efficiency, Life-eXtending) mode is a type of intermittent charging that can increase the life of some types of batteries (typically for genset applications). HELIX mode can be enabled/disabled using the keypad, the SENS Setup Utility, or by selecting a different battery type.

HELIX mode adds two DC output voltage settings to the traditional Boost and Float voltages. These are called Eco-Float and Refresh. The Eco-Float voltage is just above battery open circuit voltage, below traditional float. Refresh voltage is approximately halfway between Float and Boost voltage.

When HELIX is operating, the charger spends more than 90% of its operating hours in the Eco-Float mode. In this mode the charger uses less energy and substantially reduces the rate at which water is lost from the battery. If there are no power outages or other battery discharge events the charger periodically transitions from Eco-Float mode to Refresh mode to ensure that the battery remains fully charged. After operating in Refresh mode the charger reverts to Eco-Float mode.

9.5. Charging Low or Zero-volt Batteries

The charger includes a safety start-up voltage feature designed to prevent long-term overcharge of a battery in the event of a mismatched battery (e.g. a 120V battery is connected to a 240V charger). The default startup voltage level is factory configured to 50% of the float voltage, meaning that the charger must detect at least 50% of nominal voltage before starting. If battery voltage remains below the low battery error threshold for more than 5 minutes, the charger will alarm “Incompatible Battery” and shut

down. If DC voltage rises properly the charger will continue to charge the battery normally using standard output settings (see section 9.6 if alternate output settings are required). After correcting a mismatched condition, cycle AC and DC power to reset the charger and resume charging.

This safety feature can be temporarily defeated from the keypad or the SENS Setup Utility in order to charge/commission a zero-volt or fully discharged battery. Use the keypad or SENS Setup Utility to set the desired minimum startup voltage level and initiate a forced startup. If the startup voltage level is set to zero, initiation of the startup charge will occur automatically.

9.6. Commissioning Batteries

Some batteries require an initial “commissioning” charge that typically employs different charging voltage and current limit values than the normal charger operating values. Set the commissioning charging voltage and current limit values using the SENS Setup Utility or charger keypad. Commissioning is not available for VRLA and power supply battery types. During commissioning the Over Voltage Shutdown trip point is automatically adjusted upward to approximately 102% of the commissioning charge voltage and the temperature compensation system is deactivated. After commissioning completes, the charger automatically reverts to the settings configured for normal charging, including temperature compensation and the Over Voltage Shutdown trip point.

9.7. Battery Check

Battery Check determines if the system battery can support a parallel connected DC load. Battery Check reduces charger output voltage to a configurable backstop level to permit the battery to support the load. Once Battery Check is activated by the user it can be run either manually or scheduled to run periodically. Manually activate a Battery Check, schedule a Battery Check to run automatically and configure minimum voltage and duration using the keypad or SENS Setup Utility. Upon completion of the test, the LCD displays whether the test passed or failed for ten seconds or until the “Enter” key is pressed. An in-progress Battery Check activates a fast flashing green DC LED. Battery Check failure activates a fast flashing yellow DC LED. When this alarm is assigned to relay contacts BATTERY CHECK relay contacts change to Fail state after delay. The BATTERY CHECK alarm latches by default. Clear a latched Battery Check alarm using the keypad or SENS Setup Utility.

When chargers are connected to load share, initiating a battery check on one charger will automatically initiate a simultaneous battery check on connected charger(s).

IMPORTANT: A load less than about 3% of the charger output maximum current rating may cause inaccurate battery check results. If the system load is typically lower than 3% disable the Scheduled Battery Check feature. Battery Check will not indicate whether a battery is healthy enough to recharge switchgear relays for chargers in switchgear applications without a continuous current load.

9.8. Restore Factory Defaults

Restore factory defaults using the front panel keypad or the SENS Setup Utility. Values that will revert to original factory settings include:

- Battery type
- Cell count
- Float Voltage
- Boost Voltage
- Battery Discharge Voltage
- Low DC Voltage
- Battery End of Discharge Voltage
- High DC Voltage
- Battery Check Voltage
- Over Voltage Shutdown
- Temperature Compensation Slope
- Auto Boost Time Limit
- Periodic Scheduled Boost Interval
- Periodic Scheduled Boost Duration
- Low Current Alarm
- Battery Check Interval
- Battery Check Duration
- Commissioning Time
- Commissioning Charge Voltage
- Commissioning Current

9.9. Keypad Operation

The front panel keypad provides the ability to adjust charger settings without the SENS Setup Utility.

9.9.1. Security Code Protection

Chargers may be security code protected to ensure only authorized personnel may adjust charger settings. The default security code is 000000 meaning security code is not enabled. Change the security code to a unique value using the front panel keypad. Contact SENS Customer Service if a custom password is lost or forgotten (800-742-2326 or www.sens-usa.com).

9.9.2. Menu Navigation

Use the keypad to scroll through settings to view and adjust. The keypad provides X-Y navigation with main fields up and down and details within each field left and right (see Menu Navigation table below). Press the up and down arrow keys to scroll through main menu options. Press the left and right arrow keys to scroll through data available within each menu. Value adjustments are made with the up and down arrow keys. Press center Enter key to return to main fields. Press center Enter key twice to return to Home screen.

Menu Navigation

Step 1	↑ or ↓ for main fields
Step 2	← or → for details within each main field
Step 3	↑ or ↓ to adjust values
Step 4	↵ to return to main fields
Step 5	↵ to return to Home screen

9.9.3. Menu Options

Input, output, temperature and alarm status are displayed on the front panel LCD by default. Press the UP or DOWN arrow to access additional menus as described below. Absolute maximum voltage limits apply to all output and alarm settings. A message is displayed indicating an adjustment is limited due to settings conflict.

Main Menu <i>(Press arrows to scroll through menu options)</i>		Configurable/Viewable <i>(Press left/right arrows to scroll through menus, press up/down arrows to configure values)</i>	Parameter Descriptions
Main Menu ↑ ↓	Sub Menu ← →		
Browse Status		Scroll left/right to view basic meters and alarms	
Latched Alarms		Clear All Latched Alarms	Clear status of all latched alarms.
DC	Meters	DC Output (<i>voltage</i>)	DC output voltage and current
		DC Output (<i>power</i>)	DC output watts and % of rated output being provided
		Battery Temp.	Temperature at battery if a remote temperature sensor is connected
		Ambient Temp.	Temperature inside charger
		GF voltage	Ground Fault voltage detected by charger and indication of whether on positive or negative battery terminal
		GF Current	Ground Fault current detected by charger and indication of whether on positive or negative battery terminal

	Basic Settings	Battery Select Type	Select type of battery to be charged - flooded lead-acid, AGM, nickel-cadmium VRLA, power supply.
		Battery Select Number of Cells	Adjust number of series cells in battery string
		Float Voltage	Adjust output Float voltage, must be greater than 60% of Boost setting
		Boost Voltage	Adjust output Boost voltage from, must be same or greater than Float setting, must not be greater than 166% of Float setting
		HELIX-EcoFloat	Enable or disable HELIX mode
		Current Limit	System current limit setting. Set to "No Limit Set" for full current capacity. Set a value in amps to limit available current. It is sometimes necessary to limit maximum charging current to the battery.
		Temp. comp./°C	Adjust temperature compensation slope from 0 to -0.30%/°C
	Boost Settings	Boost Voltage	Adjust output Boost voltage from, must be same or greater than Float setting, must not be greater than 166% of Float setting
		Auto Boost Delay	Adjust amount of time from 0 to 5 minutes to delay before entering Boost mode after power is cycled or battery type is changed.
		Auto-Boost	Enable or disable Dynamic Boost mode
		Auto Boost Limit	Adjust the maximum amount of time charger will be in Dynamic Boost mode from 1 to 255 hours. The Boost time limit is reset if charger power is cycled or an engine crank is detected.
		Boost Duration	Adjust amount of time charger will be in scheduled periodic Boost mode from 1 to 255 hours. The Boost timer is reset if charger power is cycled
		Scheduled Boost	Adjust amount of time between periodic scheduled Boost events from 1 to 180 days. Set to OFF to disable.
		Run Timed Boost	Start or stop a manual Boost cycle. Will operate in Boost mode until the Boost Duration expires.
		Next Scheduled Boost	View time until next scheduled Boost
	Battery Check	Battery Check	Start or stop a manual Battery Check.
		Clear Failure Battery Check	Press UP arrow to reset/clear Battery Check alarm on selected output
		Batt Check Time	Adjust amount of time to run Battery Check from 1 to 60 minutes
		Batt Check Vmin	Adjust minimum voltage allowed during Battery Check test, must be greater than End-of-Discharge voltage and less than 98% Float voltage

	Sched Batt Check	Adjust amount of time between scheduled Battery Check tests from 1 to 90 days
	Next Sched Batt Check	View time until next scheduled Battery Check test
Alarms	Relay Delay Time DC	Adjust amount of time to delay activation of alarm relays after a DC alarm event takes place from 5 to 60 seconds. Alarm/comms circuit board alarm relay contacts and alarms on communications ports are delayed; LED alarm indication is not delayed.
	Ground Fault Alarm	Enable/disable or adjust setpoint to trigger positive or negative Ground Fault alarm.
	Low Crank	Adjust setpoint to trigger Low Crank alarm from 6V to 98% of Float, must be at least 2% less than Float setting
	Clear Failure Low Crank	Press UP arrow to reset/clear Low Cranking alarm on selected output
	End Discharge	Adjust setpoint to trigger Battery End-of-Discharge alarm, must be less than Low DC setting
	Low DC Voltage	Adjust setpoint to trigger Low DC voltage alarm, must be greater than End Discharge setting and less than Battery Discharging setting
	Batt Discharging	Adjust setpoint to trigger Battery Discharging alarm, must be between Low DC setting and 98% of Float setting or Eco-Float setting when HELIX is active
	High DC Voltage	Adjust setpoint to trigger High DC voltage alarm, must be greater than Boost by 2% of Float setting, must be less than 40% higher than Boost setting
	Overvolt Fault	Adjust setpoint to trigger Over Voltage Shutdown alarm, must be greater than High DC setting
	Low Current	Adjust setpoint to trigger Low Current alarm from 0% to 50% of nominal current
	High Batt Temp	Adjust setpoint to trigger High Battery Temperature alarm
	Hi BatTmp Shtdwn	Adjust setpoint to trigger High Battery Temperature Shutdown alarm
	Low Batt Temp	Adjust setpoint to trigger Low Battery Temperature alarm
Battery Room Temp	Adjust setpoint to trigger High Battery Room Temperature alarm	
Startup Voltage	DC Start Volts	Adjust DC Startup Voltage. Set to zero to start into zero-volt battery automatically.
	Force Startup	Enables charger to attempt to charge a battery with a voltage below the DC Startup Voltage. Only enables startup on selected output.

	Commission	Batt Commission (<i>voltage</i>)	Adjust battery commissioning output voltage must be greater than or equal to Float voltage
		Batt Commission (<i>current</i>)	Adjust battery commissioning output current from 5% to 100% of nominal current rating
		Batt Commission (<i>duration</i>)	Adjust battery commissioning hours from 1 to 120 hours
		Batt Commission (<i>enable</i>)	Start or stop commissioning cycle. Charger will deliver commissioning voltage and current until commissioning hours expire.
	Advanced Settings	Restore Factory Default Settings DC	Press UP arrow to restore settings to factory configuration
		DC Output #A	Enable for IQ units
		DC Output #B	Disable for IQ units
		DC Output #D	Disable for IQ units
	AC	Meters	AC Input
AC Reference Meters			Press UP arrow to enable displaying AC meter values in the Browse Status menu area
Basic Settings		Number of Phases	Set to 1 for single-phase input voltage
		Nominal Volts AC	Set nominal input voltage for charger model. Must match hardware jumper/terminal block on inside of charger when jumper exists.
Alarms		Relay Delay Time AC	Adjust amount of time to delay activation of alarm relays after an AC alarm event takes place from 5 to 60 seconds. Alarm/comms circuit board alarm relay contacts and alarms on communications ports are delayed; LED alarm indication is not delayed.
		Max Voltage	Adjust setpoint to trigger AC Voltage High alarm
		Min Voltage	Adjust setpoint to trigger AC Voltage Low alarm
		High Freq	Adjust setpoint to trigger AC Frequency Out of Range alarm
Advanced Settings		Low Freq	Adjust setpoint to trigger AC Frequency Out of Range alarm
		Restore Factory Default Settings AC	Press UP arrow to restore settings to factory configuration
		AC Input #A	Enable for IQ units
		User Access	AC Input #B
	UI Access Control		Select allowed user interface access. Access options include read-only/monitor viewing or full access adjustments for advanced users.

		Change Security Code	Change security code to desired 6 digits. The default security code is 000000 (disabled). Upon entering a security code, the display will automatically prompt user for the code to access protected menus. Menus are protected depending on configured level of access (see UI Access Control definitions above).
		Relock Access	Exit Service Mode and relock access
Service Tools	Output	Force DC Startup All	Enables charger to attempt to charge a battery with a voltage below the DC Startup Voltage. Enables startup on all outputs.
	Alarms	Clear Failures All	Press UP arrow to reset/clear failures on all outputs
		Clear Failure Low Crank	Press UP arrow to reset/clear Low Cranking alarm on all outputs
		Clear Failure Battery Check	Press UP arrow to reset/clear Battery Check alarm on all outputs
	Alarm Test	Relay Test	Press UP arrow to set all alarm relays and DOWN arrow to clear all relays
		Simulate Alarms	Simulate/set alarms for testing purposes. Set AC Fail, High DC, Low DC, Charger Fail and Over Voltage Shutdown alarms true. Alarm state times out after 5 minutes.
	Display	Display Type	Set to "Unit Display" to display single unit values or set to "System Display" to display system (for a system with multiple chargers) values on the unit LCD
		LCD Brightness	Adjust LCD brightness from 0 – 100%
		Display Test	Press UP arrow to set all LCD segments black and DOWN arrow to clear all LCD segments
	Advanced	Soft Reset All Devices	Press UP arrow to reset all devices in the unit/system
		Full Reboot Protocol Board	Press UP arrow to reboot protocol communications device
		Repository Config	Set to Stable
		Minimum System Number of Chargers	Not applicable to IQ chargers
		Minimum Unit Number of Chargers	Not applicable to IQ chargers
	Communications	TCP/IP Settings	TCP-IP Address
TCP-IP Gateway			Set TCP-IP Gateway
TCP-IP Subnet Mask			Set TCP-IP Subnet Mask
Hardware Mask			Reads Hardware Address (MAC address of the unit)
SENSnet		SENSnet Mode	Enable or disable SENSnet Mode. When disabled the charger will not communicate via IP address. Enabled by default.

	Modbus RS485	Modbus Configuration	Select RTU or set to OFF to disable Modbus communications. Only one RS-485 communications protocol is allowed at a time.
		Modbus Configuration Address	Adjust Modbus server address from 1 to 255. Set to OFF to disable Modbus communications.
		Modbus Configuration Parity Bit	Set Modbus parity to none, even or odd
		Modbus Configuration Baud Rate	Adjust Modbus baud rate, 230.4 Kbps maximum
		Modbus Configuration Write	Enable or disable write access via Modbus
	Modbus TCP	Modbus Configuration	Enable or disable Modbus TCP-IP
		Modbus Configuration Address	Adjust Modbus server address from 1 to 255. Set to OFF to disable Modbus communications.
		Modbus Configuration Write	Enable or disable write access via Modbus
		Modbus Configuration Max Connections	Set number of clients allowed to connect at once
	DNP3 RS485	DNP3 Configuration	Enable or disable DNP3 RS-485. Only one RS-485 communications protocol is allowed at a time.
		Source Addr	Set DNP3 source address
		Dest Addr	Set DNP3 destination address
		Parity Bit	Set DNP3 parity to none, even or odd
		Baud Rate	Adjust DNP3 baud rate, 230.4 Kbps maximum
		Conf File	Set to factory default DNP3 configuration or select one of two custom configurations. Use SENS DNP3 Config Tool to generate custom configuration file.
	DNP3 TCP	DNP3 Configuration	Enable or disable DNP3 TCP-IP
		Port	Set DNP3 port
		Source Addr	Set DNP3 source address
		Dest Addr	Set DNP3 destination address
		Conf File	Set to factory default DNP3 configuration or select one of two custom configurations. Use SENS DNP3 Config Tool to generate custom configuration file.
User CAN	User CAN Mode	Enable or disable User CAN Mode	
Alarm Relays	Relay Delay Time AC	Adjust amount of time to delay activation of alarm relays after an AC alarm event takes place from 5 to 60 seconds. Alarm/comms circuit board alarm relay contacts and alarms on communications ports are delayed; LED alarm indication is not delayed.	
	Relay Delay Time DC	Adjust amount of time to delay activation of alarm relays after a DC alarm event takes place from 5 to 60 seconds. Alarm/comms circuit board alarm relay contacts and alarms on	

		communications ports are delayed; LED alarm indication is not delayed.
	Relay Test	Press UP arrow to set all alarm relays and DOWN arrow to clear all relays
Unit Information	Serial No.	Charger serial number
	Display Revision	Software revision currently loaded on alarms/comms circuit board
	Copyright	SENS copyright year
	Charger Revision	Software revision currently loaded on charging devices

9.10. Configuration with SENS Setup Utility

The SENS Setup Utility is used to monitor, configure, and troubleshoot SENS chargers. Download the SENS Setup Utility software at sens-usa.com/support/download-center/. The setup utility allows configuration of all charger settings including alarm relay assignments. Update charger firmware for all devices except the optional communications protocol circuit board using the setup utility. Update the optional communications protocol circuit board using the ethernet connection and board webpage (see sections [6.6](#) and [9.11](#)). Connect the setup utility to the charger using the USB connector on the control circuit board (see section [6.9](#), connect using the “USB” option in the utility) or the ethernet connection on the optional communications protocol board (see section [6.6](#), connect using the “SENSnet” option in the utility). See the SENS Setup Utility user manual for further information on connecting to and communicating with the charger.

9.11. Protocol Communications Circuit Board

Connect to the optional protocol communications circuit board to update board firmware, download a support bundle, download logs or restart. Connect using the ethernet connection (see section [6.6](#)).

9.11.1. Connect to Protocol Communications Circuit Board

The charger ships from the factory set for DHCP and will automatically/dynamically obtain an IP address. View the IP or configure the charger to use a static IP address, subnet mask and gateway using the front panel display in the “Communications” menu area. Connection is typically to a building network using a router, but a direct ethernet connection to a computer is also possible.

9.11.1.1. Network Using Router/Gateway

Connect a network cable from the ethernet port on the protocol communications circuit board in the charger to the building network (typically at a router). Allow charger to obtain an IP address dynamically or set a static IP.

9.11.1.2. Direct Connect Ethernet

Connect a network cable from the ethernet port on the protocol communications circuit board in the charger directly to a computer when a building network is not available. Because the charger is not connected to a network/router it will likely take a "link local" IP address in the range 169.254.0.0 to 169.254.255.255. This works well if the computer is also configured to obtain an IP address automatically because the computer will also take an IP address in this range. If the charger does not obtain an IP address or communications are not working, review the computer port configuration. On the computer, navigate to Control Panel -> Network and Sharing Center -> Connections: Ethernet/Ethernet Adapter -> Properties -> Internet Protocol Version 4 (TCP/IPv4) -> Properties. If the computer port is configured to “Use the following IP address:” (rather than “Obtain an IP address automatically”), configure the charger to work on that network. Using the front panel, navigate to “Communications” menu area to set IP, subnet mask and gateway. Set a different static IP address on the same subnet as the computer (e.g. if computer is set to 192.168.50.34, set the charger to 192.168.50.35). Set TCP/IP Gateway to the IP address but with a 1 for the last digit (e.g. 192.168.50.1). Set the TCP/IP Subnet Mask to 255.255.255.0.

9.11.2. Verify Connection Using Webpage

Navigate to the protocol communications circuit board webpage by typing its IP address into a browser on the computer. A page similar to below will display if a connection exists.

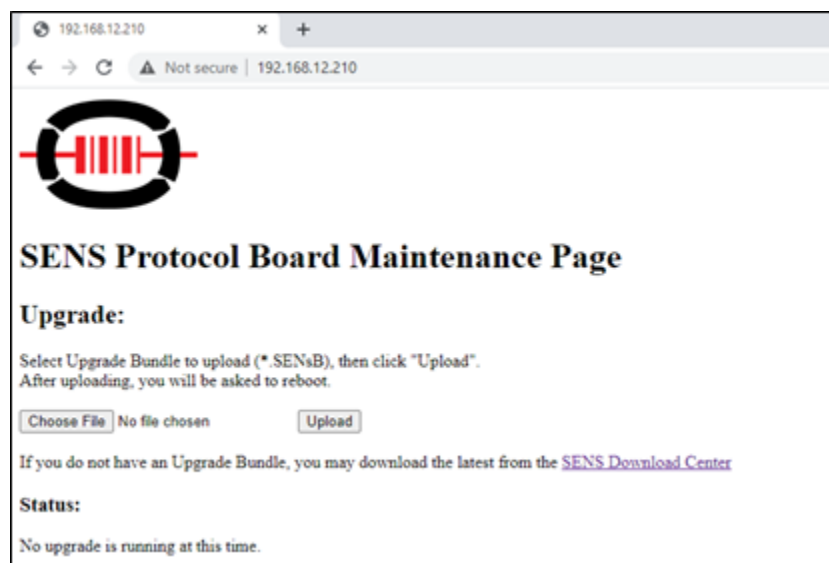

9.11.3. Update Firmware Using Webpage

Use this method to update firmware only on the protocol communications board. Update firmware for all other charger devices using the SENS Setup Utility (see section [9.10](#)).

- 9.11.3.1. Download new protocol communications board firmware bundle from the SENS website (sens-usa.com/support/download-center/). Select the appropriate download according to

the current revision of the protocol communications board. Unzip the file to extract just the firmware bundle (e.g. "SW_PROTOCOLBUNDLE_1.1.2.17405.SENSsB").

- 9.11.3.2. Connect to the protocol communications board webpage (see section 9.11.2).
- 9.11.3.3. Under the "Upgrade" section, select "Choose File," select the firmware bundle file to upload and press the "Upload" button.
- 9.11.3.4. Press the "Restart" button on the following page.
- 9.11.3.5. View update progress on the charger LCD and the protocol communications board webpage. The protocol communications circuit board will restart multiple times. Verify update is complete by confirming the new bundle version stated on the webpage.

9.12. Temperature Compensation

The charger is temperature compensated to match the negative temperature coefficient of the battery. A SENS remote temperature sensor or remote battery monitor is required for this functionality. When temperature compensation is active, the output voltage will increase slightly as temperature decreases, decrease as temperature increases, and is clamped at 0°C (32°F) and +40°C (122°F) to protect against extremely high or low output voltage (see Example Temperature Compensation Curves graph below).

The charger automatically includes local temperature compensation using internal on-board sensors. Remote temperature compensation is enabled when the external sensor is located at the batteries and connected via the optional remote temperature sensor or optional SENS remote battery monitor. Remote temperature compensation should be used in applications where battery and charger are located in different ambient conditions. Chargers connected to load share only require a remote temperature sensor connected to one charger. Temperature Compensation is set to a slope of -0.18% per °C by default for operation with batteries. Temperature compensation is disabled by setting the temperature compensation slope to zero using the keypad or SENS Setup Utility. The temperature present at a sensor (local or remote) is displayed on the front panel LCD. Actual battery temperature is only displayed if the optional remote temperature sensor is connected to the charger and placed at the batteries.

Example Temperature Compensation Curves

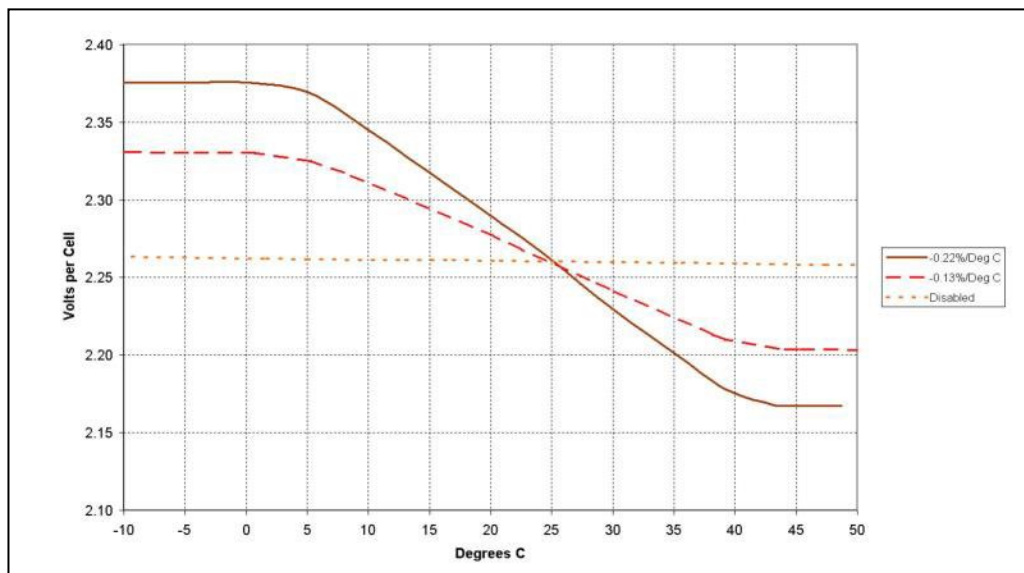

9.13. Load Share Charger Operation

Multiple chargers may be connected in parallel to provide charger redundancy and increased charging current. Load sharing chargers are fault tolerant; one charger failure will not cause failures in paralleled chargers.

9.13.1. Load Sharing and Synchronization

Connection of the load share accessory between chargers using the SENSbus RJ-45 connectors (see section [6.7](#)) automatically initiates load sharing and synchronization of all operating modes. Chargers will share the current load within $\pm 10\%$. For proper load share operation, a 120-ohm terminator is required at the ends of the SENSbus. Chargers intended for load sharing must be configured with the same output settings in order to load share properly. The LOAD SHARE FAIL alarm will occur any time a charger is unable to load share. If a charger in a multi-charger load sharing system fails or is disconnected the remaining chargers will still load share and ignore the faulted charger. Each load sharing charger will alarm independently using individually configured alarm setpoints.

The output voltage and current of each individual charger will be shown on its front panel LCD unless the LCD is set to "System Display" to display total system values (see section [9.9.3](#)). If an optional remote alarm/communications panel accessory (not included internal to charger) is connected it will display only the system output voltage and current. An alarm/communications circuit board that is configured for an individual charger can be set to show system information by using the SENS Setup Utility.

Chargers connected in parallel without the load sharing network cable will operate but without synchronization. Current is not shared between chargers, Boost and HELIX modes are not synchronized and the system voltage is not displayed on the LCD. The chargers must be set for the same voltage range (120V or 240V) and Float voltage. When load sharing is disabled, boost mode should also be disabled on all but one charger to avoid conflicts between chargers. As a result, redundancy of Boost output voltage is not included when load sharing is not employed.

10 MODBUS COMMUNICATIONS

Modbus is an application layer messaging protocol used for client/server communication and is implemented according to specifications provided by Modbus Organization (<http://www.modbus.org/specs.php>).

10.1. TCP/IP Modbus—Optional

Modbus communications over TCP/IP is optional and requires configuration using the SENS Setup Utility or the keypad (see section 9.9.3). Set the IP address as desired. It may take up to 10 seconds for the network setting changes to apply. A TCP/IP address of 0.0.0.0 implies DHCP (Dynamic) addressing. Adjust the Gateway and Subnet Mask values as required. The displayed Hardware Address is the MAC address corresponding to the Ethernet interface. This value is not adjustable. Configure Modbus server address and enable/disable Modbus write access as desired. See section 6.6 for connection information. Both Modbus TCP/IP and DNP3 TCP/IP may be used simultaneously.

TCP/IP Modbus Default Settings

Setting	Value
IP Address	0.0.0.0 DHCP/AUTO
Subnet Mask	N/A
Gateway	N/A
Port Number	502
Modbus Server Address	10

10.2. RS-485 Modbus—Optional

Serial Modbus communications over RS-485 using RTU mode is optional. Modbus communications settings may be configured using the keypad or SENS Setup Utility prior to executing communications. Configure Modbus server address, baud rate, parity and enable/disable Modbus write access as desired. See section 6.5 for connection and termination requirements. Only one RS-485 protocol is allowed at a time. Enable/disable either Modbus RS-485 or DNP3 RS-485 using the keypad or SENS Setup Utility.

Modbus RS-485 Default Settings

Setting	Value
Configuration	RTU
Baud Rate	19200
Data Bits	8
Parity	Even
Stop Bits	1
Server Address	10

10.3. Modbus Holding Registers

EnerGenius IQ products provide an extensive array of Modbus registers. These Modbus registers are organized using 32-bit big-endian. The registers are zero-indexed, meaning the first register is index zero as opposed to index 1. Some Modbus polling utilities may be one-indexed or default to little-endian and as such may need to be adjusted. To verify, poll register 9 as a 32-bit value and verify the first 6-digits match the serial number shown on the product label. If they don't match, adjust the offset (zero or one), change the endianness (sometimes referred to as swapping the registers) or both. Note that registers that do not have a scaling factor of one must be divided by the scaling factor to obtain the decimal/floating point representation.

The following are common registers that are applicable to most applications. Contact SENS for further information if necessary. See section [10.12](#) for legacy IQ Modbus information. Legacy IQ Modbus can be used in systems that were set up to poll an IQ built before May 2021. For new systems, use the following tables instead.

Address High		Address Low		Name	Description	Units	Scale Factor
Decimal	Hex	Decimal	Hex				
0	0x000	1	0x001	Unit Serial	Serial Number of System the device was built into and shipped part of	Num	1
2	0x002	3	0x003	Program Revision	Version of the main program	Num	1
4	0x004	5	0x005	Bootloader Version	Version of bootloader	Num	1
6	0x006	7	0x007	Type	Device type	Enum	1
8	0x008	9	0x009	Serial	Serial Number of the Device	Num	1
10	0x00A	11	0x00B	Build Date	Year (16bit), month(8bit), day(8bit)	Num	1
12	0x00C	13	0x00D	Model Num 1_4	Model number character	bit	1
14	0x00E	15	0x00F	Model Num 5_8	Model number character	bit	1
16	0x010	17	0x011	Model Num 9_12	Model number character	bit	1
18	0x012	19	0x013	Model Num 13_16	Model number character	bit	1
20	0x014	21	0x015	Model Num 17_20	Model number character	bit	1
22	0x016	23	0x017	Model Num 21_24	Model number character	bit	1
24	0x018	25	0x019	Model Num 25_28	Model number character	bit	1
26	0x01A	27	0x01B	Model Num 29_32	Model number character	bit	1
42	0x02A	43	0x02B	Basic Charging Alarms	Charging Alarm status bits (see section 10.4)	Bitfield	1
44	0x02C	45	0x02D	Charging Status	Charging Status bits (see section 10.5)	Bitfield	1
46	0x02E	47	0x02F	Charging Alarms Extended	Charging Alarm Extended status bits (see section 10.6)	Bitfield	1
48	0x030	49	0x031	Charging AC Alarms	Charging AC Alarm status bits (see section 10.7)	Bitfield	1
50	0x032	51	0x033	Accessory Channel Alarms	Accessory Channel Alarm status bits (see section 10.8)	Bitfield	1
52	0x034	53	0x035	Accessory System Alarms	Accessory System Alarms status bits (see section 10.9)	Bitfield	1
54	0x036	55	0x037	Accessory Assigned Charger Alarms	Accessory Assigned Charger Alarms status bits (see section 10.10)	Bitfield	1
62	0x03E	63	0x03F	Uptime Counter Value	Charger uptime counter value	Sec	1

212	0x0D4	213	0x0D5	Unit Voltage	Voltage currently being supplied by the unit to the battery/loads	V	32768
214	0x0D6	215	0x0D7	Unit Current	Current currently being supplied by the unit to the battery/loads	A	32768
216	0x0D8	217	0x0D9	Unit Power	Power currently being supplied by the unit	W	32768
218	0x0DA	219	0x0DB	Unit Float Voltage	Float Voltage Setting of the unit	V/cell	32768
220	0x0DC	221	0x0DD	Unit Boost Voltage	Boost Voltage Setting of the unit	V/cell	32768
222	0x0DE	223	0x0DF	Unit Battery Temp	Battery temperature	°C	32768
224	0x0E0	225	0x0E1	Unit Internal temp	Internal temperature of the unit	°C	32768
226	0x0E2	227	0x0E3	Unit Boost Timer	Boost timer	Sec	1
228	0x0E4	229	0x0E5	Unit Periodic Boost Countdown	Time until next Boost	Sec	1
230	0x0E6	231	0x0E7	Unit Line Frequency	AC Line Frequency	Hz	10
232	0x0E8	233	0x0E9	Unit Line Voltage 1	AC Line 1 Voltage	V	32768
234	0x0EA	235	0x0EB	Unit Line Current 1	AC Line 1 Current (not applicable to single phase chargers)	A	32768
236	0x0EC	237	0x0ED	Unit Line Voltage 2	AC Line 2 Voltage (not applicable to single phase chargers)	V	32768
238	0x0EE	239	0x0EF	Unit Line Current 2	AC Line 2 Current (not applicable to single phase chargers)	A	32768
240	0x0F0	241	0x0F1	Unit Line Voltage 3	AC Line 3 Voltage (not applicable to single phase chargers)	V	32768
242	0x0F2	243	0x0F3	Unit Line Current 3	AC Line 3 Current (not applicable to single phase chargers)	A	32768
244	0x0F4	245	0x0F5	Unit Battery Check Time Elapsed	Battery Check time elapsed	Sec	1
246	0x0F6	247	0x0F7	Unit Battery Check Due	Time until next Battery Check	Sec	1
248	0x0F8	249	0x0F9	Unit Number of Chargers	Number of modules	Num	1

10.4. Basic Charging Alarms Bit Definition

Bit Address		Name	Description
Decimal	Hex		
0	0x00	AC Fail	AC input voltage is not detected by the module/charger.
1	0x01	High DC	DC output voltage is above the High DC Voltage alarm setpoint.
2	0x02	Low DC	DC output voltage is below Low DC Voltage alarm setpoint.
3	0x03	Charger Fail	Module/charger has failed. Module/charger is not able to provide the current demanded by the battery and/or load or is providing more current than the unit's control system is commanding.
4	0x04	Over Voltage Shutdown	DC output voltage is above Over Voltage Shutdown setpoint and unit has executed a high voltage shutdown. This only occurs when the overvoltage is caused by the charger.
5	0x05	Reverse Polarity	Battery is connected backwards. Output is disabled until the condition is corrected.
6	0x06	Unused	Unused
7	0x07	Incompatible Battery	Unit is connected to an incompatible battery and is unable to bring up the output voltage after a set period of time.

8	0x08	Invalid Settings	Settings are not valid. Output is disabled until the condition is corrected.
9	0x09	Unused	Unused
10	0x0A	Thermal Fold Back	Output power has been reduced to protect from over-heating.
11	0x0B	Temperature Probe Fault	Disabled or failed remote temperature sensor. Temperature compensation is forced OFF when sensor is shorted.
12	0x0C	Current Limiting	Charger is operating at maximum allowable output, either maximum current or maximum power, whichever occurs first.
13	0x0D	Ground Fault Positive	Ground fault current to the positive output terminal is above the Ground Fault Trip sensitivity setpoint.
14	0x0E	Low Current	Output Current is under the Low Current Alarm setpoint.
15	0x0F	Load Share Fault	Modules or chargers connected for load sharing are not sharing the current load.
16	0x10	AutoBoost Lockout Active	Boost mode time limit has expired and charger has returned to Float mode. Boost mode is disabled until the time limit is reset. The Boost time limit is reset when power is cycled.
17	0x11	Unused	Unused
18	0x12	SENS Bus Inactive	Device is not communicating on SENSbus.
19	0x13	Battery On Discharge	Battery is beginning to discharge and DC output voltage is below Batt Discharge Voltage alarm setpoint.
20	0x14	Battery End Discharge	DC output voltage is below Batt End Discharge Voltage alarm setpoint.
21	0x15	Ground Fault Negative	Ground fault current to the negative output terminal is above the Ground Fault Trip sensitivity setpoint.
22	0x16	DC Negative open	Chargers connected in parallel that suffer a loss of high current negative connection may try to route power through the SENSbus cabling. This alarm shows that a charger has detected the issue and has shut itself off. Please check battery terminal connections
23	0x17	DC Below Startup Voltage	Battery voltage is below the Startup Voltage setpoint. Unit output voltage is disabled. Forced startup feature overrides.
27	0x1B	Battery Check	Battery has failed the most recent battery check.

10.5. Charging Status Bit Definition

Bit Address		Name	Description
Decimal	Hex		
0	0x00	Output Idle	Charging status - Output Idle
1	0x01	Follower Mode	Charging status - Follower Mode
2	0x02	Helix Float Charge	Charging status - Helix Float
3	0x03	Float Charge	Charging status - Float Charge
4	0x04	Helix Refresh Charge	Charging status - Helix Refresh Charge
5	0x05	Auto Boost Charge	Charging status - Auto Boost Charge
6	0x06	Periodic Boost Charge	Charging status - Periodic Boost Charge
7	0x07	Battery Check Active	Charging status - Battery Check Active
8	0x08	Commission Charge	Charging status - Commission Charge
9	0x09	High Charger Current	Output current is more than rated current.

10	0x0A	Unused	Unused
11	0x0B	Unused	Unused
12	0x0C	Using Battery Temperature	Charger reading battery temperature and is compensating the voltage.
13	0x0D	UltraCap Mode Active	Charger is set to charge an Ultra Capacitor.
14	0x0E	Battery Check Passed	Battery Check test successfully passed

10.6. Charging Alarms Extended Bit Definition

Bit Address		Name	Description
Decimal	Hex		
0	0x00	Check Filter	Module has experienced a thermal roll back which can be caused by a clogged input air filter.
1	0x01	Thermal Fault	Module/charger has faulted because it over-heated and thermal fold-back has reached zero watts. Module/charger output has been disabled.
2	0x02	High Battery Temperature	Battery temperature is above the High Battery Temperature alarm setpoint.
3	0x03	High Battery Temperature Shutdown	Battery temperature is high enough that the unit has shut off for safety precautions. Only available when a remote battery temperature sensor is installed with the optional remote battery monitor.
4	0x04	High AC Ripple Detected on Output	Charger's output ripple is above High AC Ripple Detection alarm setpoint.
5	0x05	DC Output Open	Charger has detected that the output is not connected to anything.
6	0x06	Charger Low Temperature	Unit ambient temperature is below its rated ambient temperature, unit output may be derated.
7	0x07	Battery Low Temperature	Battery temperature is below Battery Low Temperature alarm setpoint. Only available when a remote battery temperature sensor is installed with the optional remote battery monitor.

10.7. Charging AC Alarms Bit Definition

Bit Address		Name	Description
Decimal	Hex		
0	0x00	Unused	Unused
1	0x01	AC Phase Missing	An AC phase is missing or out of range. Only available in a 3-phase capable device.
2	0x02	AC Voltage Over Maximum	AC Voltage has gone above max AC voltage allowed by the charger on any phase. NOTE: This alarm has a delay of 3 seconds. Output has been disabled.
3	0x03	AC Voltage Low	AC Voltage has gone below AC Min Voltage alarm setpoint.
4	0x04	AC Frequency Out Of Range	AC Frequency is outside of the AC High Frequency and AC Low Frequency alarm setpoints.
5	0x05	AC Voltage High	AC Voltage is above the AC Max Voltage alarm setpoint.

10.8. Accessory Channel Alarms Bit Definition

Bit Address		Name	Description
Decimal	Hex		
0	0x00	Invalid Settings	Setting for this channel are invalid and must be corrected before settings may be sent to the chargers on this channel.
1	0x01	Low Current Channel	Channel Current is below Low Current alarm setpoint.
2	0x02	Invalid System Config	System configuration settings are invalid.

10.9. Accessory System Alarms Bit Definition

Bit Address		Name	Description
Decimal	Hex		
0	0x00	Invalid System Config	Configuration of system is conflicted. Charger will continue to operate but may not be fully functional until the issue is resolved.
1	0x01	AC1 SPD	The AC supplementary surge protector has expired and needs replacement.
2	0x02	AC1 Breaker	The AC breaker is OPEN or has tripped. Only available with Breaker Status option.
3	0x03	Unused	Unused
4	0x04	Unused	Unused
5	0x05	DC SPD	The DC supplementary surge protector has expired and needs replacement.
6	0x06	DC Breaker	The DC breaker is OPEN or has tripped. Only available with Breaker Status option.
7	0x07	Unused	Unused
8	0x08	Unused	Unused
9	0x09	Unused	Unused
10	0x0A	Unused	Unused
11	0x0B	System Display Board	This device is configured as a system display board. It will present information for the entire system, even if devices are not in its unit.
12	0x0C	Unused	Unused
13	0x0D	SENSbus Inactive	No other devices are found on SENSbus.
14	0x0E	Unused	Unused
15	0x0F	Unused	Unused
16	0x10	Unused	Unused
17	0x11	Unused	Unused
18	0x12	No Power Board Data	No power boards are found on SENSbus.

10.10. Accessory Assigned Channel Alarms Bit Definition

Bit Address		Name	Description
Decimal	Hex		
0	0x00	Invalid Config	The configuration of one or more power modules in the unit is invalid.
1	0x01	Individual Module Fault	A power module in the unit has faulted.

10.11. Writable Control Flags (Coils)

Single coil writes: 0xFF00 for ON, 0x0000 for OFF

Address		Description	Details
Decimal	Hex		
16	0x010	Start/stop manual boost	ON to start, OFF to stop
17	0x011	Reset periodic boost charge schedule	ON to reset schedule, OFF is no-op
18	0x012	Start/stop battery check	ON to start, OFF to stop
19	0x013	Reset periodic battery	ON to reset schedule, OFF is no-op
20	0x014	Clear battery check failure	ON to reset alarm, OFF is no-op
21	0x015	Not applicable	Not applicable
22	0x016	Force DC Startup	ON to start, OFF to stop
23	0x017	Reset Latched Alarms	ON to reset alarm, OFF is no-op

10.12. Legacy IQ Modbus

Use the below tables for Modbus information using legacy IQ registers. Legacy IQ Modbus would be used in systems that were set up to poll an IQ built before May 2021. For new systems, use the tables in previous sections instead.

10.12.1. Legacy IQ Modbus Holding Registers

Address High		Address Low		Name	Description	Units	Scale Factor
Decimal	Hex	Decimal	Hex				
12288	0x3000	12288	0x3000	Float Setpoint per Cell	Vdc per cell, 22200 = 2.220V/cell	V/cell	10000
12289	0x3001	12289	0x3001	Equalize Setpoint per Cell	Vdc per cell, 23500 = 2.350V/cell	V/cell	10000
12290	0x3002	12290	0x3002	Equalize AC On Delay	Minutes equalize inhibited after AC on	Mins	1
12291	0x3003	12291	0x3003	Equalize Time Limit	Manual equalize time-out	Hrs	1
12292	0x3004	12292	0x3004	Equalize Time Interval	Days between scheduled equalize cycles	Days	1
12293	0x3005	12293	0x3005	Volt per Cell Temp. Coefficient	-mVdc/cell/°C, 400 = -4mV/cell/°C	Num	-100
12294	0x3006	12294	0x3006	Current Limit Percentage	% Rated Adc, 10500 = 105%	A	10000
12295	0x3007	12295	0x3007	Low Current Alarm	% Rated Adc, 25 = 25%, 51% = OFF	A	100
12296	0x3008	12296	0x3008	High DC Alarm per Cell	Vdc per cell, 24500 = 2.450V/cell	V/cell	10000
12297	0x3009	12297	0x3009	Over Voltage Shutdown	Vdc per cell, 24500 = 2.450V/cell	V/cell	10000
12298	0x300A	12298	0x300A	Batt. Disch. Alarm. per Cell	Vdc per cell, 20500 = 2.050V/cell	V/cell	10000
12299	0x300B	12299	0x300B	Low DC Alarm. per Cell	Vdc per cell, 18500 = 1.850V/cell	V/cell	10000
12300	0x300C	12300	0x300C	End Disch. Alarm per Cell	Vdc per cell, 17500 = 1.750V/cell	V/cell	10000
12301	0x300D	12301	0x300D	Ground Alarm Sensitivity	Enumerated: 0 = OFF, 1 = Low Leakage, 2 = Medium Leakage, 3 = High Leakage	Enum	N/A
12302	0x300E	12302	0x300E	Alarm Relay Delay	Seconds delayed (except AC fail)	Secs	1
12303	0x300F	12303	0x300F	Battery Test Alarm per Cell	Vdc per cell, 20000 = 2.000V/cell	V/cell	10000
12304	0x3010	12304	0x3010	Battery Check Duration	Length of battery check, minutes	Mins	1
12305	0x3011	12305	0x3011	Battery Check Interval	Days between scheduled checks	Days	1

12306	0x3012	12306	0x3012	DC Bus Minimum	Vdc per cell, 20000 = 2.000V/cell	V/cell	10000
12307	0x3013	12307	0x3013	Obsolete - Redundancy Check per Cell	Obsolete - Vdc per cell, 2175 = 2.175V/cell	V/cell	1
12308	0x3014	12308	0x3014	Obsolete - Redundancy Check Duration	Obsolete - Length of Redundancy check	Secs	1
12309	0x3015	12309	0x3015	Obsolete - Redundancy Check Interval	Obsolete - Minutes between scheduled checks	Mins	1
12310	0x3016	12310	0x3016	Cell Count	Number of cells in battery string	Num	1
12311	0x3017	12311	0x3017	Cell Chemistry	Enumerated: 0 = NICD, 1 = VRLA, 2 = FLA	Enum	1
12312	0x3018	12312	0x3018	Auto-Boost Time Limit	Automatic boost time-out	Hrs	1
12313	0x3019	12313	0x3019	Ground Alarm Current	Ground fault trip current	uA	1
12416	0x3080	12416	0x3080	Real-Time Clock Second	Second: 0-59, UTC	Secs	1
12417	0x3081	12417	0x3081	Real-Time Clock Minute	Minute: 0-59, UTC	Mins	1
12418	0x3082	12418	0x3082	Real-Time Clock Hour	Hour: 0-23, UTC	Hrs	1
12419	0x3083	12419	0x3083	Real-Time Clock Day of Week	Day of Week: 1-7 = Sun-Sat UTC	Num	1
12420	0x3084	12420	0x3084	Real-Time Clock Date	Date: 1-31 UTC	Num	1
12421	0x3085	12421	0x3085	Real-Time Clock Month	Month: 1-12 = Jan-Dec, UTC	Mo	1
12422	0x3086	12422	0x3086	Real-Time Clock Year	Year: 0-99 (starting at 0 = 2000) UTC	Yr	1
61440	0xF000	61440	0xF000	Network Protocol	Enumerated: 0 = OFF, 1 = serial Modbus ASCII, 2 = serial Modbus RTU, 3 = Modbus TCP/IP, 4 = serial DNP3, 5 = DNP3 TCP/IP	Enum	1
61441	0xF001	61441	0xF001	RS-485 Parity	Enumerated: 0 = None (2 stop bits), 1 = Odd (1 stop bit), 2 = Even (1 stop bit)	Enum	1
61442	0xF002	61442	0xF002	RS-485 Data Rate Baud/10 (approx. char/sec)	120 = 1200 Baud, 240 = 2400 Baud, 480 = 4800 Baud, 960 = 9600 Baud, 1440 = 14400 Baud, 1920 = 19200 Baud (default), 2880 = 28800 Baud, 3840 = 38400 Baud, 5760 = 57600 Baud, 11520 = 115200 Baud	Num	0.1
61443	0xF003	61443	0xF003	RS485 On/Off Delay	Bus transceiver enable/disable delay	msec	1
61444	0xF004	61444	0xF004	Number of data bits	Automatic by mode: 7 or 8	Num	1
61445	0xF005	61445	0xF005	Number of stop bits	Automatic by parity: 1 or 2	Num	1
61456	0xF010	61456	0xF010	tcplpAddr3	TCP/IP address: 64 bits, high order to low order	bits	1
61457	0xF011	61457	0xF011	tcplpAddr2			1
61458	0xF012	61458	0xF012	tcplpAddr1			1
61459	0xF013	61459	0xF013	tcplpAddr0			1
61460	0xF014	61460	0xF014	subNetMask3	TCP/IP subnet mask: 64 bits, high order to low order	bits	1
61461	0xF015	61461	0xF015	subNetMask2			1
61462	0xF016	61462	0xF016	subNetMask1			1
61463	0xF017	61463	0xF017	subNetMask0			1
61464	0xF018	61464	0xF018	networkGateway3	Gateway address: 64 bits, high order to low order	bits	1
61465	0xF019	61465	0xF019	networkGateway2			1
61466	0xF01A	61466	0xF01A	networkGateway1			1

61467	0xF01B	61467	0xF01B	networkGateway0		bits	1
61468	0xF01C	61468	0xF01C	networkTimeOut	Network time-out parameter	msec	1
61488	0xF030	61488	0xF030	Modbus Address	Modbus serial interface address (1-247, default: 10)	Num	1
61489	0xF031	61489	0xF031	TCP/IP Port	Port number for TCP/IP, default: 502	Num	1

10.12.2. Legacy IQ Modbus Input Registers

Address High		Address Low		Name	Description	Units	Scale Factor
Decimal	Hex	Decimal	Hex				
8192	0x2000	8192	0x2000	Equalize Timer	Minutes remaining for this equalize cycle	Min	1
8193	0x2001	8193	0x2001	Battery Check Timer	Seconds remaining for this battery check	Sec	1
8194	0x2002	8194	0x2002	Unused	Unused	N/A	N/A
8195	0x2003	8195	0x2003	Remote Temperature Sensor	Remote Temp. sensor reading 235 = 23.5°C	°C	10
8196	0x2004	8196	0x2004	System Output Current	Total of all active chargers 65535 = 655.35Adc	A	100
8197	0x2005	8197	0x2005	System Output Voltage	Average of all active chargers 65535 = 655.35Vdc	V	100
8198	0x2006	8198	0x2006	Internal Temperature Sensor	Highest reading of all chargers 235 = 23.5°C	°C	10
8199	0x2007	8199	0x2007	Percent AC Line Voltage	Average of all active chargers 100 = 100% nominal of AC tap	V	1
8200	0x2008	8200	0x2008	Rated Output Current	Total of all assigned chargers 65535 = 655.35A	A	100
8201	0x2009	8201	0x2009	Rated Output Voltage	Lowest of all assigned chargers 65535 = 655.35V	V	100
8202	0x200A	8202	0x200A	Assigned Charger Count	Number of chargers supplying output	Num	1
8448	0x2100	8448	0x2100	Charger1 Rated Output Voltage	12, 24, 48, 120, or 240 Vdc	V	1
8449	0x2101	8449	0x2101	Charger1 Rated Output Current	6, 12, 16, 25, 35, 50, 75, 100, or 150 Adc	A	1
8450	0x2102	8450	0x2102	Charger1 Output Voltage	1351 = 13.51Vdc	V	100
8451	0x2103	8451	0x2103	Charger1 Output Current	4950 = 49.50Adc	A	100
8452	0x2104	8452	0x2104	Charger1 Percent Input Voltage	101 = 101% of rated input voltage	%	1
8453	0x2105	8453	0x2105	Charger1 Internal Temperature Sensor	Temp. comp. sensor reading, 235 = 23.5°C	°C	10
8454	0x2106	8454	0x2106	Charger1 Heat Sink Temperature	850 = 85.0°C	°C	10
8455	0x2107	8455	0x2107	Charger1 Uptime Months	28 day "months" (0-1775)	Num	1
8456	0x2108	8456	0x2108	Charger1 Uptime Hours	hours (0-671)	Hrs	1
8457	0x2109	8457	0x2109	Charger1 Uptime Minutes	minutes (0-59)	Mins	1

8458	0x210A	8458	0x210A	Charger1 Uptime Seconds	seconds (0-59)	Secs	1
8459	0x210B	8459	0x210B	Charger1 Output Channel	Enum: 0=default, 1..4=ChA-ChD	Enum	1
8704	0x2200	8704	0x2200	Charger2 Rated Output Voltage	12, 24, 48, 120, or 240 Vdc	V	1
8705	0x2201	8705	0x2201	Charger2 Rated Output Current	6, 12, 16, 25, 35, 50, 75, 100, or 150 Adc	A	1
8706	0x2202	8706	0x2202	Charger2 Output Voltage	1351 = 13.51Vdc	V	100
8707	0x2203	8707	0x2203	Charger2 Output Current	4950 = 49.50Adc	A	100
8708	0x2204	8708	0x2204	Charger2 Percent Input Voltage	101 = 101% of rated input voltage	%	1
8709	0x2205	8709	0x2205	Charger2 Internal Temperature Sensor	Temp. comp. sensor reading, 235 = 23.5°C	°C	10
8710	0x2206	8710	0x2206	Charger2 Heat Sink Temperature	850 = 85.0°C	°C	10
8711	0x2207	8711	0x2207	Charger2 Uptime Months	28 day "months" (0-1775)	Num	1
8712	0x2208	8712	0x2208	Charger2 Uptime Hours	hours (0-671)	Hrs	1
8713	0x2209	8713	0x2209	Charger2 Uptime Minutes	minutes (0-59)	Mins	1
8714	0x220A	8714	0x220A	Charger2 Uptime Seconds	seconds (0-59)	Secs	1
8715	0x220B	8715	0x220B	Charger2 Output Channel	Enum: 0=default, 1..4=ChA-ChD	Enum	1

10.12.3. Legacy IQ Input Status (Bits)

Address		Description	Details
Decimal	Hex		
0	0x0000	Nonvolatile Memory Read Error	On indicates error encountered when reading on-board nonvolatile memory
1	0x0001	Real-Time Clock Error	On indicates RTC data is invalid.
2	0x0002	Remote Temp Sensor Error	When true remote temperature sensor reading is not available
3	0x0003	Remote Temp Sensor High	When true indicates Temp sensor error is > High threshold
4	0x0004	Remote Temp Sensor Low	When true indicates Temp sensor error is < Low threshold
5	0x0005	Charger 1 Comm Fail	True = Protocol Board has lost communications with Charger 1
6	0x0006	Charger 2 Comm Fail	True = Protocol Board has lost communications with Charger 2
256	0x0100	Charger1 Summary Alarm	Alarm status: On = Alarm, Off = OK (CHARGER FAIL, AC FAIL, HIGH DC, GROUND FAULT, LOW DC, BATTERY CHECK, BATTERY END-OF-DISCHARGE)
257	0x0101	Charger1 Charger Fail Alarm	Alarm status: On = Alarm, Off = OK
258	0x0102	Charger1 AC Fail Alarm	Alarm status: On = Alarm, Off = OK
259	0x0103	Charger1 High DC Voltage Alarm	Alarm status: On = Alarm, Off = OK
260	0x0104	Charger1 Ground Fault Alarm	Alarm status: On = Alarm, Off = OK (Positive or Negative Ground Fault)
261	0x0105	Charger1 Battery Fault Alarm	Alarm status: On = Alarm, Off = OK (Battery Check)
262	0x0106	Charger1 Low DC Voltage Alarm	Alarm status: On = Alarm, Off = OK

263	0x0107	Charger1 End Discharge Limit Alarm	Alarm status: On = Alarm, Off = OK
264	0x0108	Charger1 Equalize Charge	Equalize charge active (any reason)
265	0x0109	Charger1 Current Limit	Output at maximum current
266	0x010A	Charger1 Thermal Limit	Thermal protection active
267	0x010B	Charger1 DC Breaker Open	DC breaker open
268	0x010C	Charger1 Reverse Polarity	Reverse polarity at output
269	0x010D	Charger1 Positive Ground	Positive ground fault
270	0x010E	Charger1 Negative Ground	Negative ground fault
271	0x010F	Charger1 Battery Discharge	Voltage below discharge threshold
272	0x0110	Obsolete - Charger1 Redundancy Check	Obsolete - Charger will not support system load
273	0x0111	Charger1 OverVoltage Shutdown	True = an overvolt condition has caused charger to shut down.
274	0x0112	Charger1 Low Output Current	True = Output current is below low current alarm setting
275	0x0113	Charger1 Battery Over Temp	True = Battery is too hot for safe charging
276	0x0114	Charger1 Temp Sensor Fail	True = Temperature sensor thermistor is open or shorted
512	0x0200	Charger2 Summary Alarm	Alarm status: On = Alarm, Off = OK (CHARGER FAIL, AC FAIL, HIGH DC, GROUND FAULT, LOW DC, BATTERY CHECK, BATTERY END-OF-DISCHARGE)
513	0x0201	Charger2 Charger Fail Alarm	Alarm status: On = Alarm, Off = OK
514	0x0202	Charger2 AC Fail Alarm	Alarm status: On = Alarm, Off = OK
515	0x0203	Charger2 High DC Voltage Alarm	Alarm status: On = Alarm, Off = OK
516	0x0204	Charger2 Ground Fault Alarm	Alarm status: On = Alarm, Off = OK (Positive or Negative Ground Fault)
517	0x0205	Charger2 Battery Fault Alarm	Alarm status: On = Alarm, Off = OK (Battery Check)
518	0x0206	Charger2 Low DC Voltage Alarm	Alarm status: On = Alarm, Off = OK
519	0x0207	Charger2 End Discharge Limit Alarm	Alarm status: On = Alarm, Off = OK
520	0x0208	Charger2 Equalize Charge	Equalize charge active (any reason)
521	0x0209	Charger2 Current Limit	Output at maximum current
522	0x020A	Charger2 Thermal Limit	Thermal protection active
523	0x020B	Charger2 DC Breaker Open	DC breaker open
524	0x020C	Charger2 Reverse Polarity	Reverse polarity at output
525	0x020D	Charger2 Positive Ground	Positive ground fault
526	0x020E	Charger2 Negative Ground	Negative ground fault
527	0x020F	Charger2 Battery Discharge	Voltage below discharge threshold
528	0x0210	Obsolete - Charger2 Redundancy Check	Obsolete - Charger will not support system load
529	0x0211	Charger2 OverVoltage Shutdown	True = an overvolt condition has caused charger to shut down.
530	0x0212	Charger2 Low Output Current	True = Output current is below low current alarm setting
531	0x0213	Charger2 Battery Over Temp	True = Battery is too hot for safe charging
532	0x0214	Charger2 Temp Sensor Fail	True = Temperature sensor thermistor is open or shorted

10.12.4. Legacy IQ Writable Control Flags (Coils)

Single coil writes: 0xFF00 for ON, 0x0000 for OFF

Address		Description	Details
Decimal	Hex		
4096	0x1000	Periodic Equalize	Repeat timed equalize cycles at scheduled intervals - READ ONLY
4097	0x1001	Periodic Battery Check	Invoke battery check at scheduled intervals
4098	0x1002	Obsolete - Periodic Redundancy Test	Obsolete - Repeat both redundancy tests at scheduled intervals
4099	0x1003	Temperature Compensation	Enable battery voltage temperature compensation - READ ONLY
4100	0x1004	Timed Equalize	Perform single timed equalize cycle
4101	0x1005	Automatic Equalize	Enable automatic, time-limited equalize charge - READ ONLY
4102	0x1006	Float Mode	Disables timed and automatic equalize charging, disables Helix, Ultra-Cap and Power Supply modes - READ ONLY
4103	0x1007	Battery Check	Perform a single timed battery check. Battery check begins on rising edge. Falling edge forces early termination.
4104	0x1008	Obsolete - Redundancy Check	Obsolete - Perform a single redundancy check
4105	0x1009	Demand Based Equalize	Perform a single equalize cycle
4864	0x1300	Obsolete - Network Access	Obsolete - Allow/disallow network write access. Write access is through USB only.
4865	0x1301	Obsolete - Multiple Chargers Installed	Obsolete - True indicates more than one charger is installed
4866	0x1302	Obsolete - Save Settings	Obsolete - Writing a non-zero value saves all settings to non-volatile memory

11 DNP3 COMMUNICATIONS

DNP3 is a messaging protocol used for client/server communication and is implemented according to IEEE Standard 1815-2012. The EnerGenius IQ is compliant with DNP3 Subset Level 2 and supports various features of Level 3 and Level 4. EnerGenius IQ products provide an extensive amount of DNP3 information. The information in below sections includes common data points that are applicable to most applications. The entire list of DNP3 data points is available in the SENS DNP3 Config Tool (see section [11.3](#)).

11.1. TCP/IP DNP3—Optional

DNP3 communications over TCP/IP is optional and requires configuration using the SENS Setup Utility or the keypad (see section [9.9.3](#)). Set the IP address as desired. It may take up to 10 seconds for the network setting changes to apply. A TCP/IP address of 0.0.0.0 implies DHCP (Dynamic) addressing. Adjust the Gateway and Subnet Mask values as required. The displayed Hardware Address is the MAC address corresponding to the Ethernet interface. This value is not adjustable. Configure remaining DNP3 values and enable/disable DNP3 access as desired. See section [6.6](#) for connection information. Both DNP3 TCP/IP and Modbus TCP/IP may be used simultaneously.

TCP/IP DNP3 Default Settings

Setting	Value
IP Address	0.0.0.0 DHCP/AUTO
Source Address	4
Destination Address	3
Port Number	20000

11.2. RS-485 DNP3—Optional

Serial DNP3 communications over RS-485 is optional. Communications settings may be configured using the keypad or SENS Setup Utility. Configure DNP3 values and enable/disable DNP3 access as desired. See section [6.5](#) for connection and termination requirements. Only one RS-485 protocol is allowed at a time. Enable/disable either DNP3 RS-485 or Modbus RS-485 using the keypad or SENS Setup Utility.

DNP3 RS-485 Default Settings

Setting	Value
Source Address	4
Destination Address	3
Baud Rate	9600
Parity	None

11.3. SENS DNP3 Config Tool

The SENS DNP3 Config Tool is a worksheet that allows user configuration of all DNP3 data points. EnerGenius IQ products ship with a default DNP3 configuration. Use the SENS DNP3 Config Tool to create a customized DNP3 configuration file. The SENS DNP3 Config Tool is available from the communications protocol circuit board webpage (see sections [6.6](#) and [9.11](#)). Follow instructions on the “Overview” tab of the SENS DNP3 Config Tool to modify configuration and load the configuration file to the communications protocol circuit board. Select to use the custom configuration on the charger using the SENS Setup Utility or keypad.

11.4. Implementation Table

Object	Variation Number	Description
1	0	Binary Input (default)
1	1 (default)	Binary Input
1	2	Binary Input With Status
2	0	Binary Input Change (default)
2	1	Binary Input Change without Time
2	2	Binary Input Change with Time
2	3 (default)	Binary Input Change With Relative Time
10	0	Binary Output (default)
10	1	Binary Output
10	2 (default)	Binary Output Status
12	1	Control Relay Output Block
30	0	Analog Input (default)
30	1	32-Bit Analog Input with Flag
30	2	16-Bit Analog Input with Flag
30	3 (default)	32-Bit Analog Input without Flag
30	4	16-Bit Analog Input without Flag
30	5	32-Bit Floating Point with Flag
30	6	64-Bit Floating Point with Flag
32	0	Analog Change Event (default)
32	1 (default)	32-Bit Analog Change Event without time
32	2	16-Bit Analog Change Event without time
32	5	32-Bit Floating Point Analog Change Event without Time
32	6	64-Bit Floating Point Analog Change Event without Time
32	7	32-Bit Floating Point Analog Change Event with Time
32	8	64-Bit Floating Point Analog Change Event with Time
34	0	Analog Input Reporting Deadband (default)
34	1	16-Bit Analog Input Reporting Deadband
34	2 (default)	32-Bit Analog Input Reporting Deadband
34	3	32-Bit Floating Point Analog Input Reporting Deadband
40	0	Analog Output Status
40	1 (default)	32-Bit Analog Output Status
40	2	16-Bit Analog Output Status
40	3	32-Bit Floating Point Analog Output Status
40	4	64-Bit Floating Point Analog Output Status
50	0	Time and Date
50	1 (default)	Time and Date
50	3	Time and Date Last Recorded Time
60	0	Class 0, 1, 2, and 3 Data
60	1	Class 0 Data
60	2	Class 1 Data
60	3	Class 2 Data
60	4	Class 3 Data
80	1	Internal Indications (IIN)

11.5. Binary Inputs

Point	Name	Description	Default Class
0	Summary High DC	High DC detected at output terminals of unit	1
1	Summary Low DC	Output voltage is below the Low DC Voltage Threshold	1
2	Summary Charger Fail	Unit has failed or cannot produce output. Reset charger to clear alarm. If alarm continues, contact customer service.	1
3	Summary AC Fail	AC not detected by the unit	1
4	Summary Ground Fault Positive	Ground fault current to the positive output terminal is above the threshold.	1
5	Summary Ground Fault Negative	Ground fault current to the negative output terminal is above the threshold.	1
6	Summary Alarm Summary	Summary of first 6 Binary Inputs	1
7	Summary Over Voltage Shutdown	High DC voltage and output current seen on unit. Reset charger to clear alarm. If alarm continues, contact customer service.	1
9	Summary Forced Load Sharing Enabled	Load sharing is enabled when multiple charger modules are present	1
10	Summary Using Battery Temperature	Charger has a battery temperature and is compensating the voltage	1
11	Summary Temperature Probe Fault	The unit does not detect a temperature probe or the probe connection is shorted (temp comp is forced off if shorted).	1
12	Summary Equalize mode	Charger is in either Auto Boost or Periodic Boost mode	1
20	Summary AC Phase Missing	An AC phase is missing or out of range in a 3-phase capable device	2
21	Summary AC Voltage Over Maximum	AC Voltage has gone above max allowed by the charger on any phase. NOTE: This alarm has a delay of 3 seconds	2
22	Summary AC Voltage Low	AC Voltage has gone below specification of the charger	2
23	Summary AC Frequency Out Of Range	AC Frequency is outside of adjustable limits	2
24	Summary AC Voltage High	AC Voltage is above the max adjustable limit	2
40	Summary Reverse Polarity	Reverse Polarity Voltage is seen at the output terminals of the unit.	2
41	Summary Low Cranking	A low crank has been detected. Reset with the crank analyzer or by resetting the charger.	2
42	Summary Incompatible Battery	Charger was unable to bring up the output voltage after a set period of time. Example: Connecting a 12V battery when the charger is set for 24V. To clear alarm reset the charger or remove and replace a jumper.	2
43	Summary Invalid Settings	The current settings in the charger (Factory, Program, or Jumper) are not compatible with this charger. Please re-check and try again.	2

44	Summary Thermal Fold Back	Charger components are over maximum temperature; so, the power output has been lowered.	2
45	Summary Current Limiting	Charger is outputting maximum current.	2
46	Summary Low Current	Output Current is under the low current alarm threshold.	2
47	Summary Load Share Fault	Unit is unable to fully load share with other units on the SENSbus. This is typically caused by units not having the same settings.	2
48	Summary AutoBoost Lockout Active	Boost mode is disabled because the charger hit the boost time limit. This will reset upon detection of a crank, or detection of loss of AC for a set period of time.	2
49	Summary Battery On Discharge	Output voltage is below the Battery Discharge Voltage Threshold	2
50	Summary Battery End Discharge	Output voltage is below the Battery End Discharge Voltage Threshold	2
51	Summary DC Negative open	Chargers connected in parallel that suffer a loss of high current negative connection may try to route power through the SENSbus cabling. This alarm shows that a charger has detected the issue and has shut itself off. Please check battery terminal connections	2
52	Summary DC Below Startup Voltage	DC is below the startup voltage; so, the charger cannot startup.	2
53	Summary Fan Fail	There is a problem with one or more of the fans	2
54	Summary Battery Check Failed	Battery has failed the most recent battery check	2
55	Summary Helix Float Charge	Charger Mode	2
56	Summary Float Charge	Charger Mode	2
57	Summary Helix Refresh Charge	Charger Mode	2
58	Summary Auto Boost Charge	Charger Mode	2
59	Summary Periodic Boost Charge	Charger Mode	2
60	Summary Battery Check Active	Charger Mode	2
61	Summary Commission Charge	Charger Mode	2
62	Summary Battery Check Passed	Battery has passed the most recent Battery Check	2
63	Summary Check Filter	Charger has experienced a thermal roll back which can be caused by a clogged filter. Please check the filter and clean it if needed	2
64	Summary Thermal Fault	Charger has faulted because it over heated. This can be environmental or a sign that a fan is not working properly	2
65	Summary High Battery Temperature	Battery is above the high battery temp threshold	2
66	Summary High Battery Temperature Shutdown	Battery Temperature is high enough that the charger has shut off as a safety concern	2
67	Summary High AC Ripple Detected on Output	Charger's output ripple is above limit	2

68	Summary DC Output Open	Charger has detected that the output is not connected to anything	2
69	Summary Charger Low Temperature	Charger is currently below its rated temperature, output may be derated	2
70	Summary Battery Low Temperature	Battery is below adjustable temperature limit (disabled if no temperature is available)	2
71	Summary Invalid Settings DC	Settings on this channel are invalid and must be corrected before settings may be sent to the chargers on this channel.	2
72	Summary Invalid System Config	Configuration of system is conflicted. Charger will continue to run, but may not be fully functional until the issue is resolved.	2
73	Summary AC1 SPD	The surge arrestor has faulted	2
74	Summary AC1 Breaker	The breaker has faulted	2
75	Summary AC2 SPD	The surge arrestor has faulted	2
76	Summary AC2 Breaker	The breaker has faulted	2
77	Summary DC SPD	The surge arrestor has faulted	2
78	Summary DC Breaker	The breaker has faulted	2
79	Summary Sensbus Inactive	There are no other devices found on SENSbus	2
80	Summary No Power Board Data	There are no power boards found on SENSbus	2
81	Summary Module Missing	Number of modules in system or unit is less than expected	2
82	Summary Individual Module Fault	Charger module has a fault	2
83	Summary Invalid Settings AC	Settings on this channel are invalid and must be corrected before settings may be sent to the chargers on this channel.	2
84	Summary DNP Config File Error	Invalid configuration file for DNP, usually a file syntax error.	2

11.6. Binary Outputs

Point	Name	Description
10	DC ChannelA Start/stop manual boost	Start/stop manual boost. PULSE_ON to start, PULSE_OFF to stop
11	DC ChannelA Reset periodic boost charge schedule	Reset periodic boost charge schedule. PULSE_ON to reset schedule.
12	DC ChannelA Start/stop battery check	Start/stop battery check. PULSE_ON to start, PULSE_OFF to stop
13	DC ChannelA Reset periodic battery check schedule	Reset periodic battery check schedule. PULSE_ON to reset schedule.
14	DC ChannelA Clear battery check failure	Clear battery check failure. PULSE_ON to reset alarm.
15	DC ChannelA Clear low cranking failure	Clear low cranking failure. PULSE_ON to reset alarm.
16	DC ChannelA Force DC Startup	Force DC Startup. PULSE_ON to force DC Startup.
17	DC ChannelA Reset Latched Alarms	Reset Latched Alarms. PULSE_ON to Reset Latched Alarms.

11.7. Analog Inputs

Point	Name	Description	Units	Default Class	Default Deadband
0	Program Revision	Revision of application code	Num	2	1
1	DNP Revision	Revision of DNP	Num	2	1
8	Setup Error Code	Error Code defined in manual (0=No Error)	Num	2	1
20	Unit Serial	Unit Serial Number of Device	Num	2	1
21	Serial	Serial Number of Protocol Board	Num	2	1
22	Build Date	Build date (byte0=Day, byte1=Month, byte2-3=Year)	Num	2	1
40	DC ChannelA Voltage	Output Voltage	mV	1	10
41	DC ChannelA Current	Output Current	mA	1	10
42	DC ChannelA Power	Output Power	W	1	10
43	DC ChannelA Battery Temperature	Temperature used for compensation if applicable	mC	1	10
44	DC ChannelA Number Of Chargers	Number of Charger Modules on this DC channel	Num	2	1
45	DC ChannelA Maximum Power	Maximum power rating	W	2	1
46	DC ChannelA Maximum Voltage	Maximum voltage rating	mV	2	10
47	DC ChannelA Maximum Current	Maximum current output	mA	2	10
48	DC ChannelA Periodic Boost Countdown	Number of seconds until next scheduled boost	Sec	2	1
49	DC ChannelA Battery Check Due	Number of seconds until next battery check	Sec	2	1
50	DC ChannelA State Timer	Number of seconds elapsed in present state	Sec	2	1
60	AC ChannelA Line Voltage 1	AC Line Voltage on Phase 1	mVac	1	10
61	AC ChannelA Line Current 1	AC Line Current on Phase 1	mAac	1	10
62	AC ChannelA Line Voltage 2	AC Line Voltage on Phase 2	mVac	1	10
63	AC ChannelA Line Current 2	AC Line Current on Phase 2	mAac	1	10
64	AC ChannelA Live Voltage 3	AC Line Voltage on Phase 3	mVac	1	10
65	AC ChannelA Line Current 3	AC Line Current on Phase 3	mAac	1	10
66	AC ChannelA Line Frequency	AC Line Frequency	mHz	1	10
67	AC ChannelA Number Of Chargers	Number of Charger Modules on this AC channel	Num	2	1

11.8. Analog Outputs

Point	Name	Units
10	DC Alarm Delay	Sec
11	AC Alarm Delay	Sec
30	DC ChannelA End Discharge VPC	mV/cell
31	DC ChannelA Low DC VPC	mV/cell
32	DC ChannelA Battery Discharge VPC	mV/cell
33	DC ChannelA Battery Check VPC	mV/cell
34	DC ChannelA High DC VPC	mV/cell
35	DC ChannelA OVSD VPC	mV/cell
36	DC ChannelA Float Charge VPC	mV/cell
37	DC ChannelA Boost Charge VPC	mV/cell
38	DC ChannelA Commissioning VPC	mV/cell
39	DC ChannelA Cell Count	Num
40	DC ChannelA Commissioning Duration	Min
41	DC ChannelA Periodic Boost Interval	Hour
42	DC ChannelA Temp Comp Slope (400 = -4mV/cell/C)	-mVdc/cell/C
43	DC ChannelA Current Limit	A/A rated
44	DC ChannelA Ground Fault Trip Point	uA
48	DC ChannelA Low Crank VPC	mV/cell
49	DC ChannelA Low Current Alarm	A/A rated
50	DC ChannelA Auto Boost Time Limit	Min
52	DC ChannelA Battery Check Interval	Min
53	DC ChannelA Battery Check Duration	Min
54	DC ChannelA Commissioning Current	A/A rated
55	DC ChannelA Channel Rated Unit Current	mA
56	DC ChannelA Channel Rated Unit Power	W
57	DC ChannelA Startup Voltage	mV/cell
58	DC ChannelA Periodic Boost Duration	Min
62	DC ChannelA AC Voltage On Output Limit	mVac
63	DC ChannelA Battery High Temperature Limit	mC
64	DC ChannelA Battery High Temperature Shutdown	mC
65	DC ChannelA Battery Low Temperature Limit	mC
66	DC ChannelA High Battery Room Temperature Limit	mC
67	DC ChannelA Battery Over Room Temperature Limit	mC
101	AC ChannelA AC Low Frequency Limit	mHz
102	AC ChannelA AC High Frequency Limit	mHz
103	AC ChannelA High Voltage Limit	mVac
104	AC ChannelA Low Voltage Limit	mVac
105	AC ChannelA Number Of Phases Expected	Num

12 MAINTENANCE AND TROUBLESHOOTING

WARNING:
CHARGER CONTROL CIRCUITS ARE AT BATTERY POTENTIAL AND CAN BE HAZARDOUS IF TOUCHED. ONLY INSULATED TOOLS SHOULD BE USED WHILE WORKING ON A CHARGER THAT IS POWERED UP. AVOID TOUCHING ANY CIRCUIT OR ANY BARE METAL.

Recommended Maintenance:

- A. Annually: Check all field wiring connections for electrical and mechanical integrity, verifying no corrosion or loose hardware is present
- B. Annually: Verify that convection cooling vents are not blocked or clogged
- C. Every 10 years: If the charger is typically operated at ambient temperatures above 30°C (86°F), replace the filter capacitors. Regardless of ambient temperatures, replace the filter capacitors if high charger output ripple is not desired.

If you suspect there is a problem with the charger, the following should be done immediately:

- A. Disconnect AC mains supply.
- B. Open both AC input and DC output circuit breakers.
- C. Open the front door of the charger and inspect the interior for loose objects.
- D. Examine connector locations on printed circuit board for loose or un-plugged connectors.
- E. Reconnect AC mains supply.
- F. Check AC input voltage on the line side of input breaker with an external voltmeter and verify it is in the proper range.
- G. Check wiring to DC output breaker and verify proper polarity of output connections. Also verify small wires connected to load side of DC output breaker are still connected.

If none of these inspections yield a solution, consult section [12.1](#) for additional troubleshooting tips and section [12.2](#) for configuration error codes.

12.1. Troubleshooting Charts

Troubleshooting chart for repeated AC breaker trip

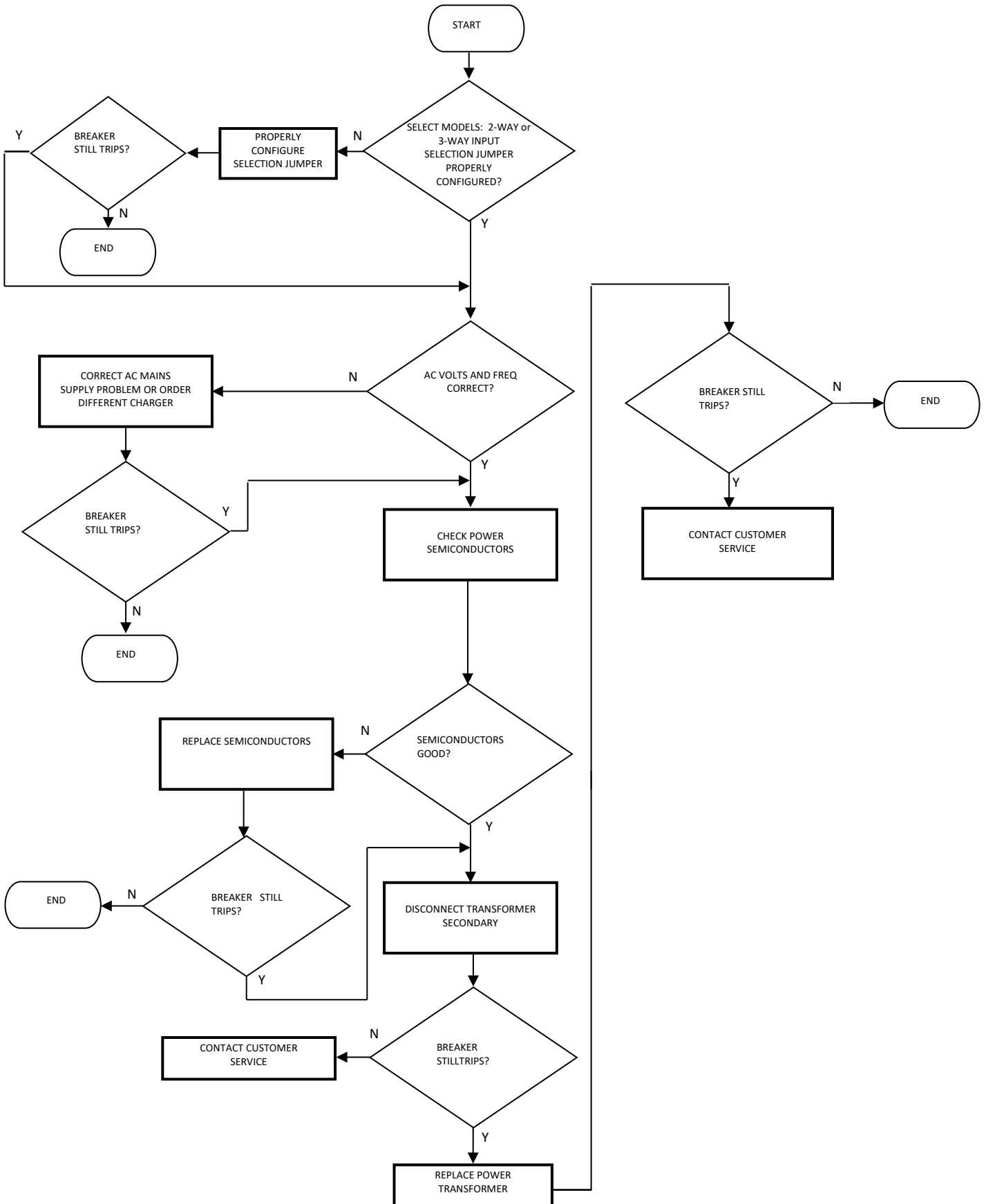

Troubleshooting flowchart for AC FAIL alarm indication

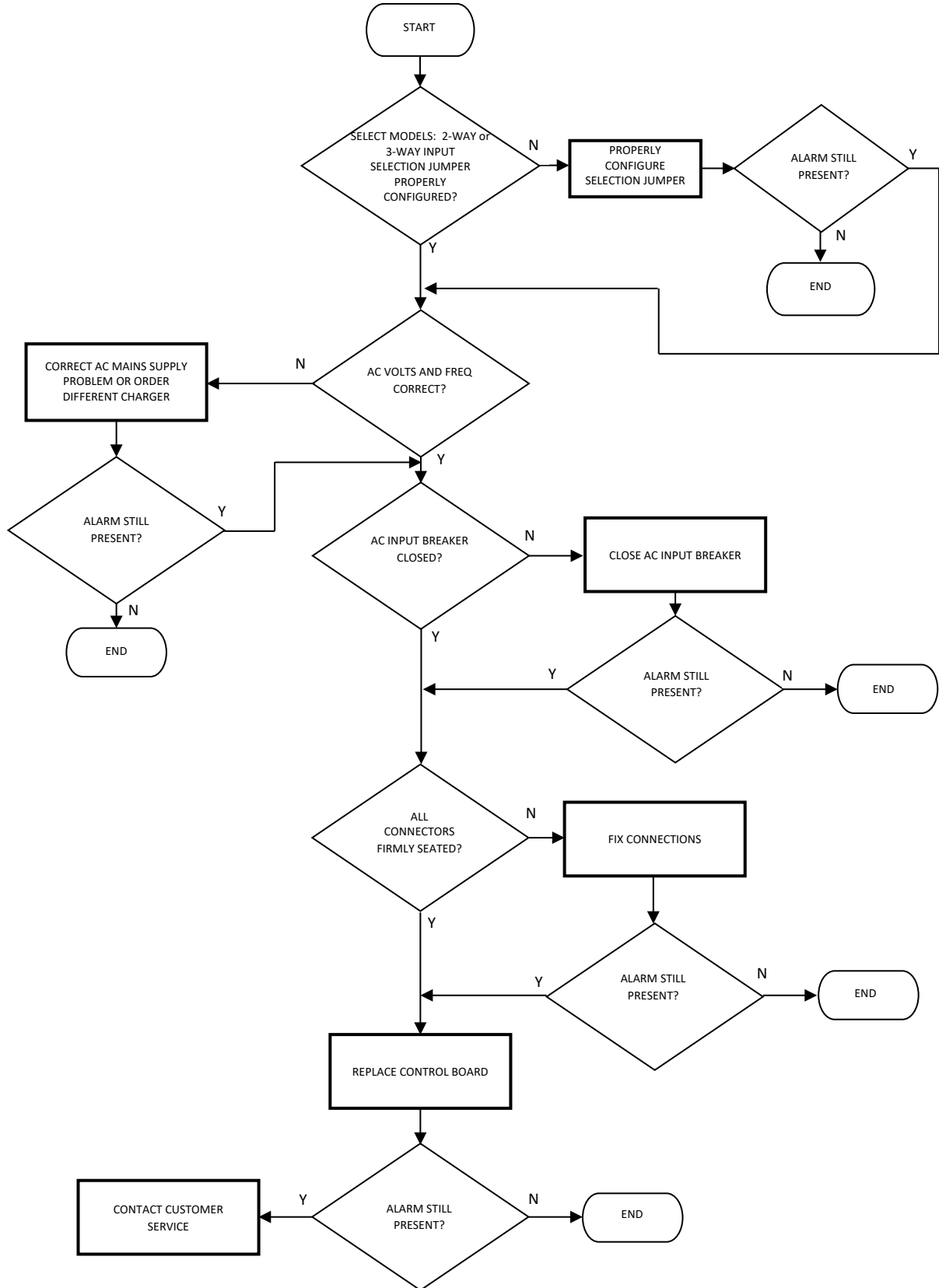

Troubleshooting flowchart for CHARGE FAIL alarm

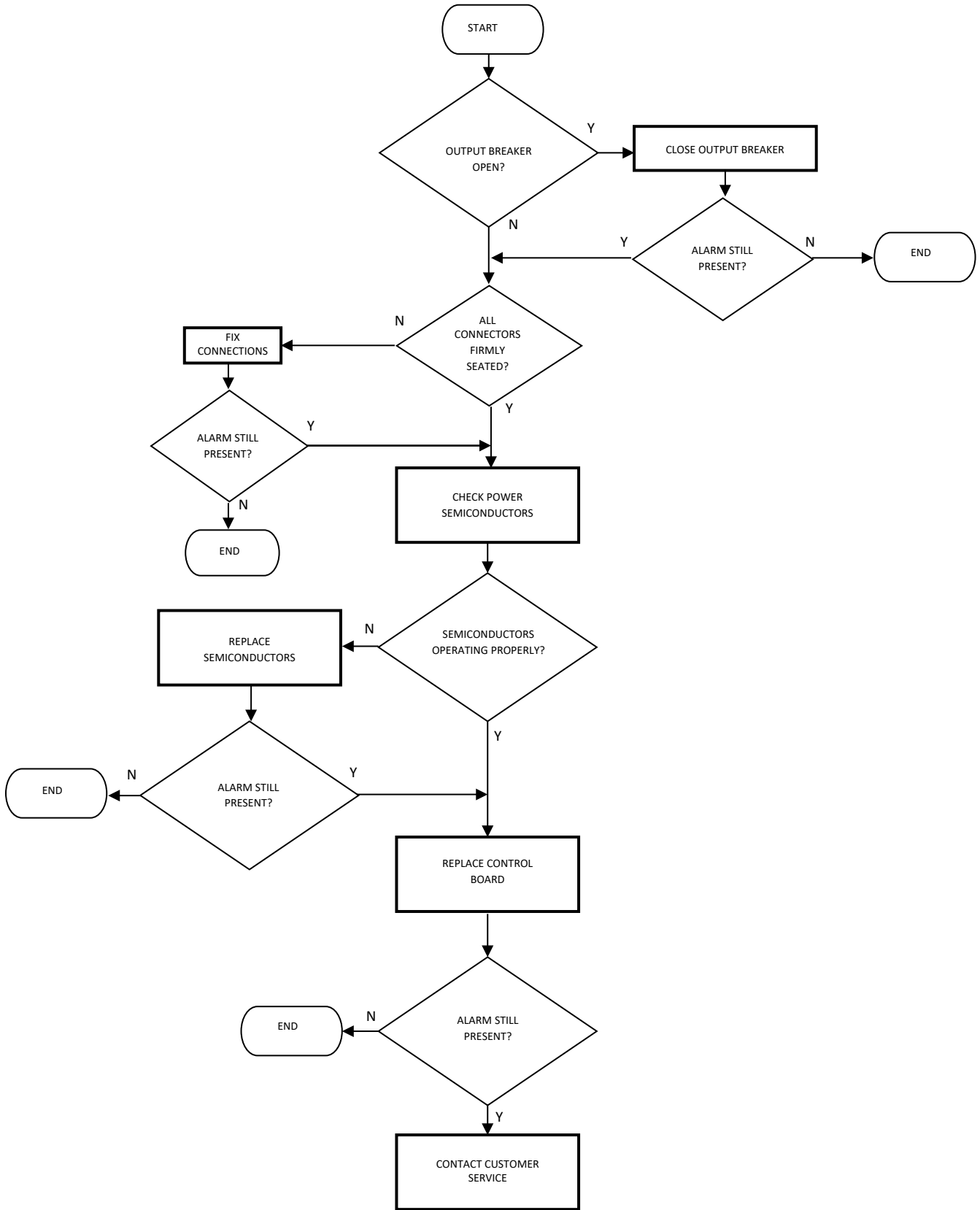

Troubleshooting flowchart for DC output breaker trip

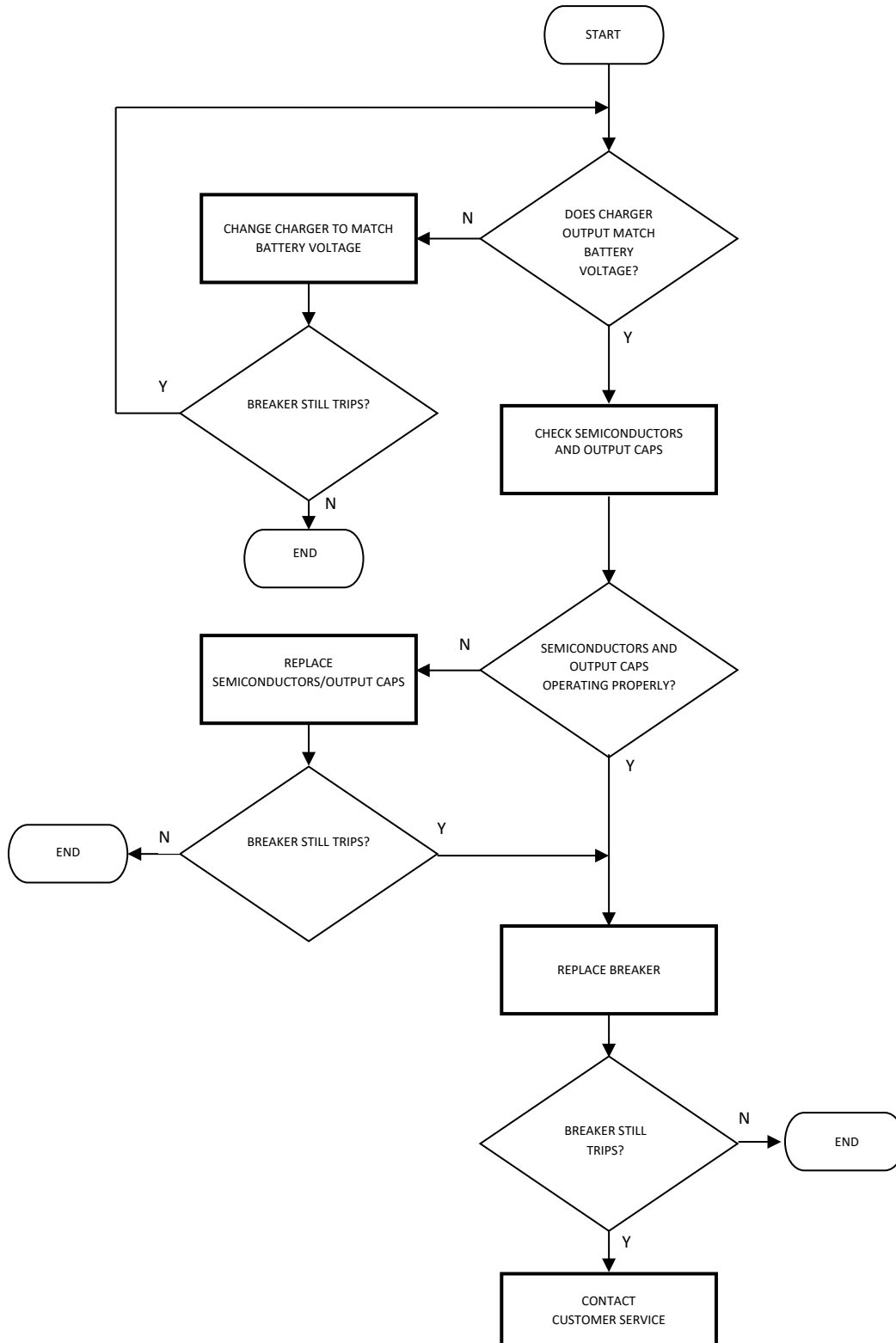

Troubleshooting flowchart for HIGH DC or OVER VOLTAGE SHUTDOWN alarms

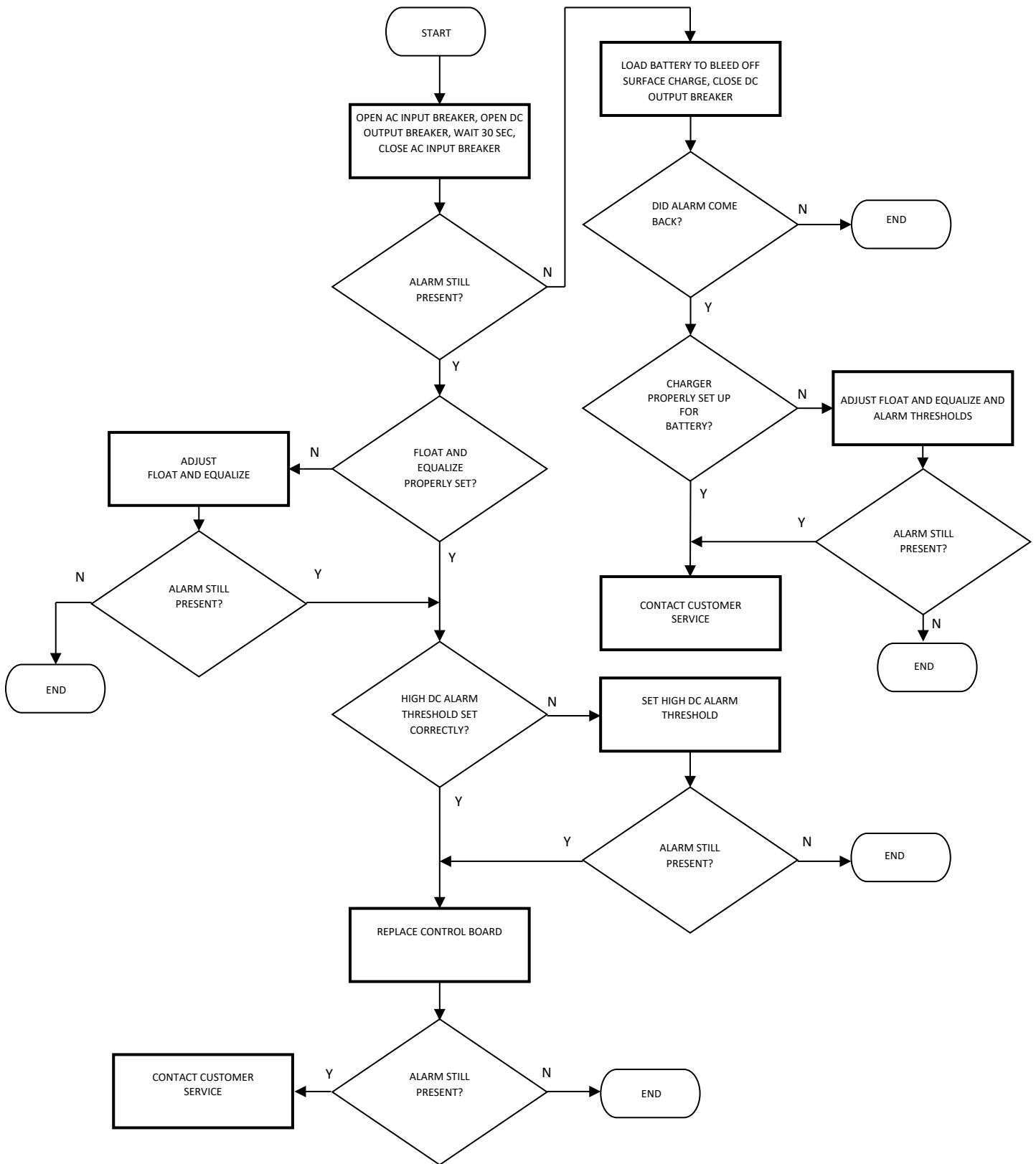

Troubleshooting flowchart for LOW DC alarm

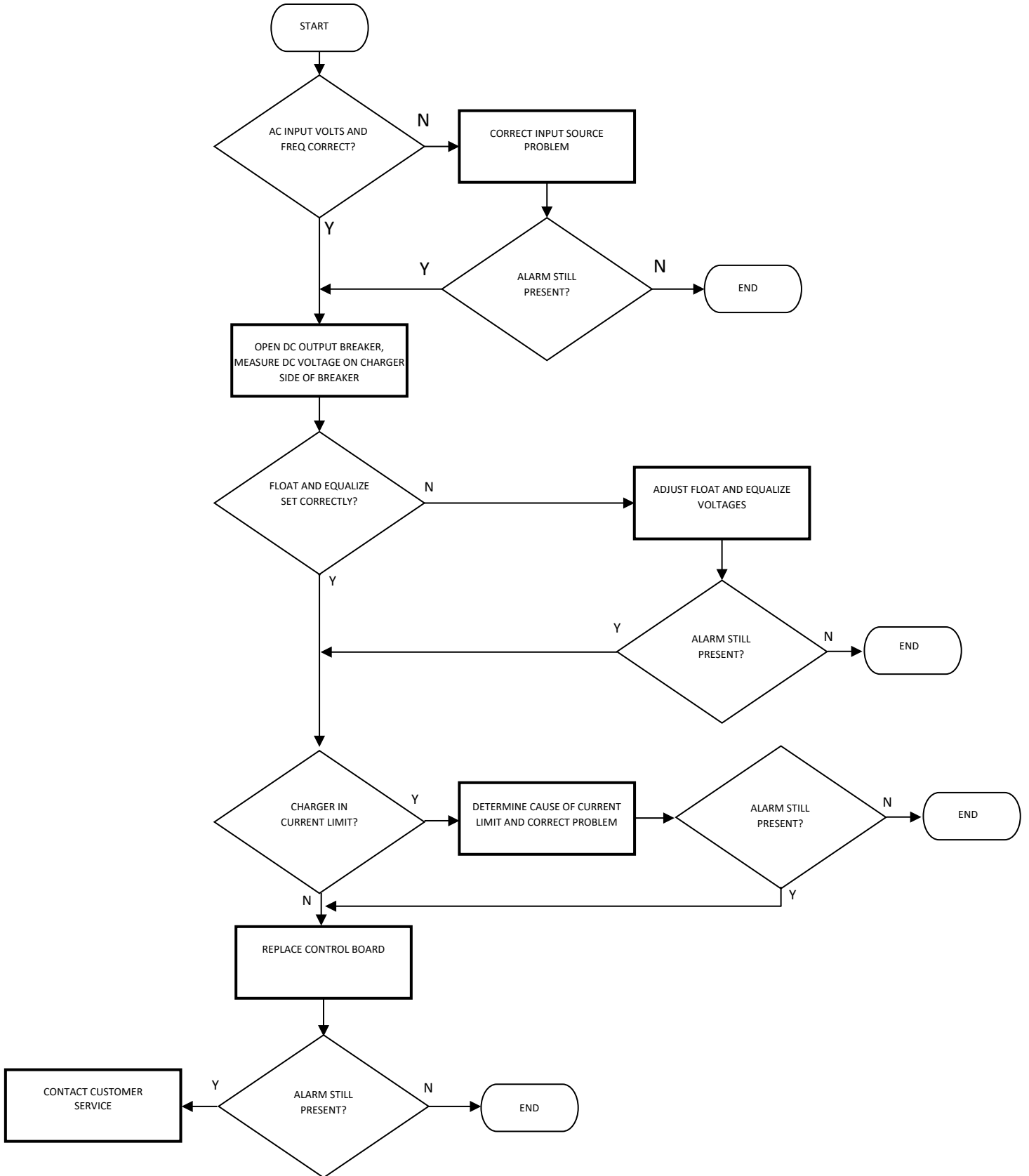

Troubleshooting flowchart for no output

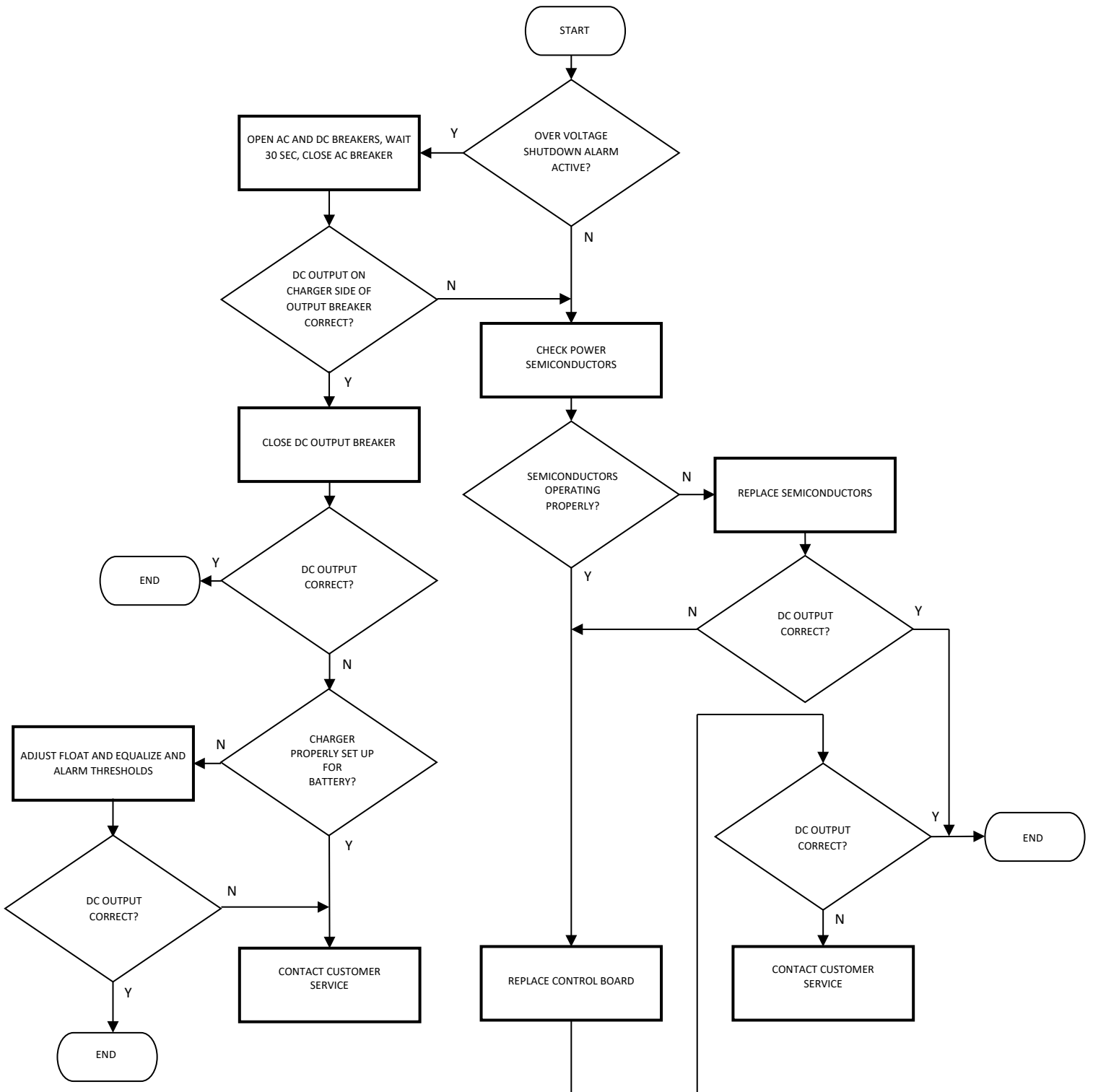

Troubleshooting flowchart for GROUND FAULT alarm

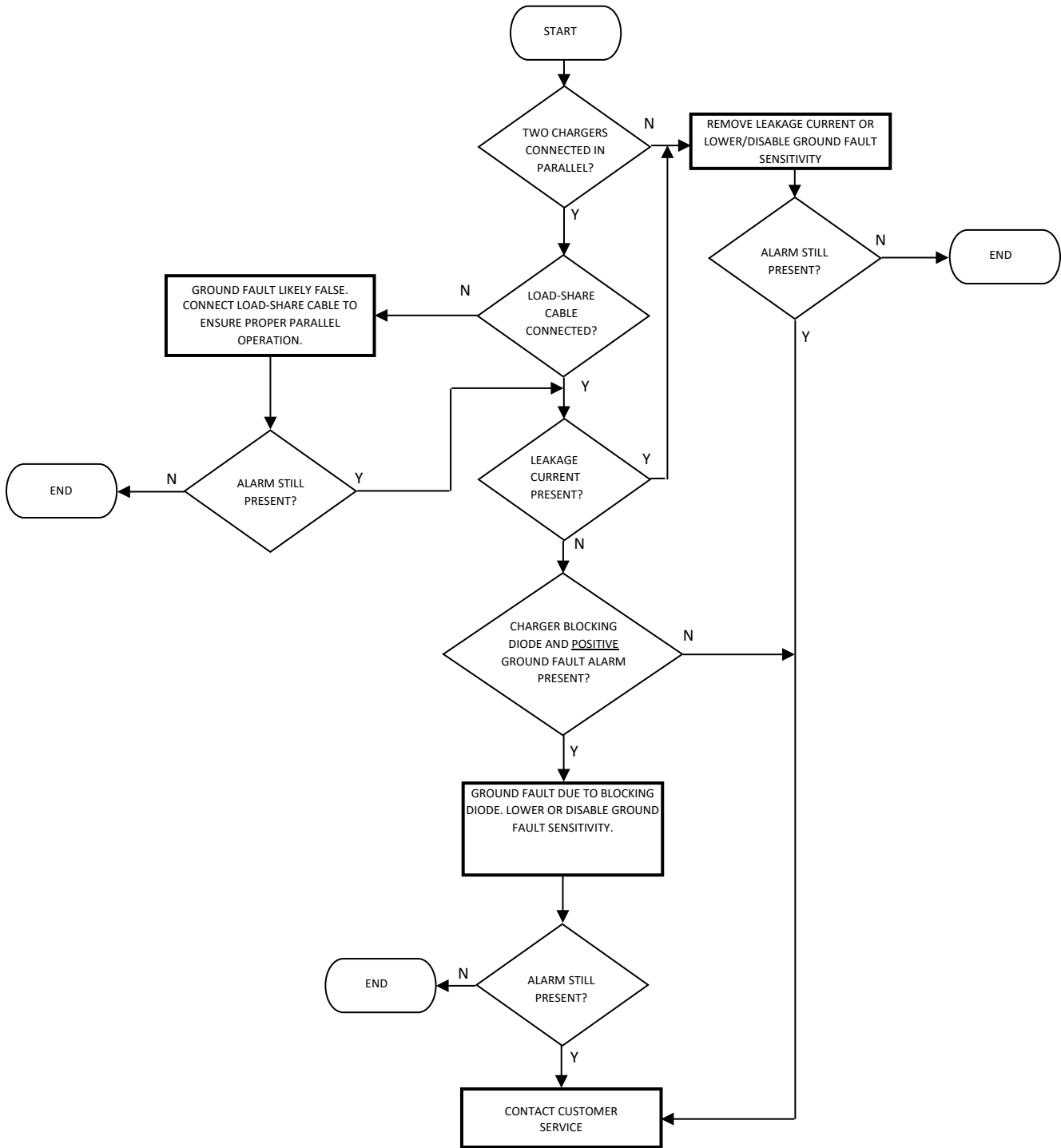

12.2. Configuration Error Codes

Error codes are displayed on front panel LCD.

Error	Scope	Description	Corrective Action
104	Charger	Invalid output channel. Chargers must be set to use a valid output channel setting: output channel A for single output chargers.	<ul style="list-style-type: none"> - If necessary, enable the channel using the keypad " DC Output #" selection in the "DC -> Advanced Settings" menu or the setup utility. - To select a different output channel, reassign the charger using the setup utility.
201	Channel	No chargers assigned to output channel. Every enabled output channel must have at least one charger assigned to it. When none is found, it is presumed that a charger has failed, has lost SENSbus data communication, or has an incorrect channel setting.	<ul style="list-style-type: none"> - Check for a charger that has failed (indicated by its LED status). - Check for disconnected or damaged SENSbus data cables. - If the output channel is not to be used, disable it by using the keypad "Enable/Disable DC Output Ch" setting in the " DC -> Advanced Settings " menu or the setup utility.
202	Channel	Too few chargers operating. The combined output rating of all chargers operating on this channel is less than the channel's rated output. This can occur because a charger has failed, has an open AC input or DC output connection, has lost SENSbus data communication, is configured for the wrong output channel, etc.	<p>Each charger must be set for the output channel corresponding to its electrical DC output connection. Enable channel A and disable channels B through D using the keypad "DC Output #" selection in the "DC -> Advanced Settings" menu or the setup utility.</p> <ul style="list-style-type: none"> - Use the setup utility to verify the channel DC output current and power ratings. - Check for disconnected or damaged SENSbus data cables. - Check for miswired, disconnected, or damaged input and output connections.

203	Channel	<p>Charger assigned to a disabled channel. All chargers must be set to a valid output channel that is enabled in this unit or system.</p>	<ul style="list-style-type: none"> - Enable channel A and disable channels B through D using the keypad "DC Output #" selection in the "DC -> Advanced Settings" menu or the setup utility. - To select a different output channel, reassign the using the setup utility.
305	Unit (or System)	<p>Rogue Module Found. This can apply to any type of system. It indicates that a charger module was found that has a Unit Serial Number that does not match any display found on the bus. This could happen when adding a module from another system.</p>	<p>Corrective action is to fix Unit Serial Numbers on all chargers/modules and Accessory boards.</p>

13 GLOSSARY

Original Factory Configuration	Configuration set at the factory. Charger operates using settings configured at the factory per customer order. See configuration details on front door label.
Float Voltage	Float output voltage is used to maintain batteries in a fully charged state and prevents a fully charged battery from becoming overcharged.
Boost Voltage	“Boost” describes an elevated output voltage employed to accelerate the recharge of a battery that is periodically discharged. The voltage employed to boost charge batteries is typically the same as that employed to “equalize” cells of a battery on long-term float charge. The terms “Boost” and “Equalize” are often used interchangeably. SENS’ convention is to employ the term “Boost” when referring to both the fast recharge function and the cell equalization function described under the definition of “Equalize Voltage”.
Equalize Voltage	“Equalize” describes an elevated voltage typically employed to reset the series-connected cells of a battery such that cell voltages and capacities more nearly match each other. Equalize charging is employed to improve the performance and life of an already charged battery that is primarily charged using Float voltage. SENS’ convention is to employ the term “Boost” to mean both this cell equalization function and the fast battery recharge function.
Battery Type	Indicates the type of battery being charged. Battery type is selected when ordering charger and may be adjusted using the front panel keypad. Supported battery types include flooded lead-acid, absorbed glass mat (AGM), valve-regulated lead-acid, and nickel-cadmium.
Configuration Code	Indicates charger output voltage configuration. Configuration code is included on the front door label.
Modbus	Modbus is an application layer messaging protocol provided by Modbus Organization and used for client/server communication. Modbus is provided over RS-485 in RTU mode or over TCP/IP as an option.

DCN	REV	DESCRIPTION	DATE	APPROVED
108031	A	INITIAL RELEASE	4/20/2021	JWF
108104	B	SHEET 5, UPDATE JUMPER SETTINGS VIEW	8/31/2021	JWF

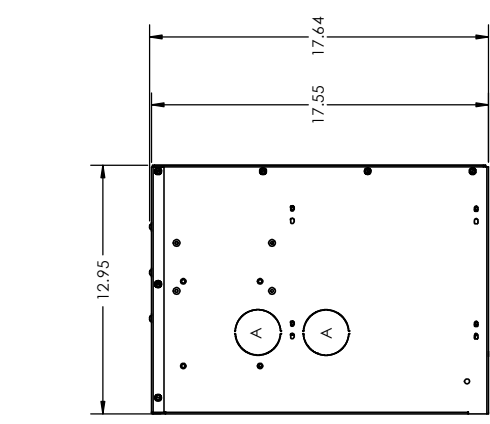

Right

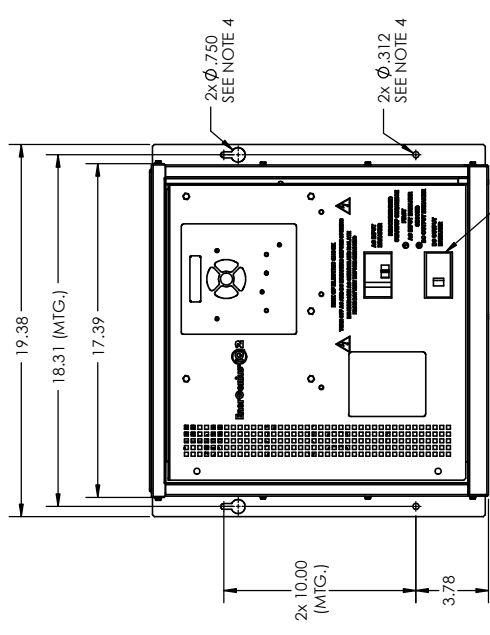

Front

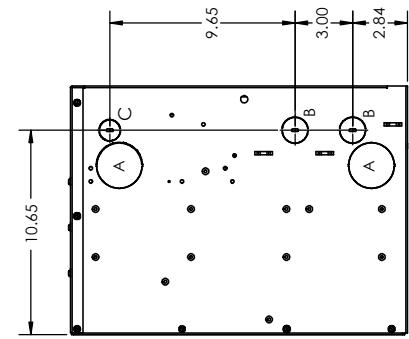

Left

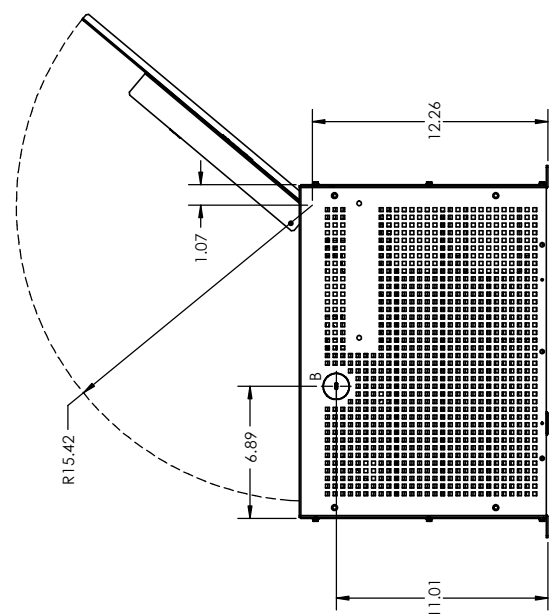

Bottom

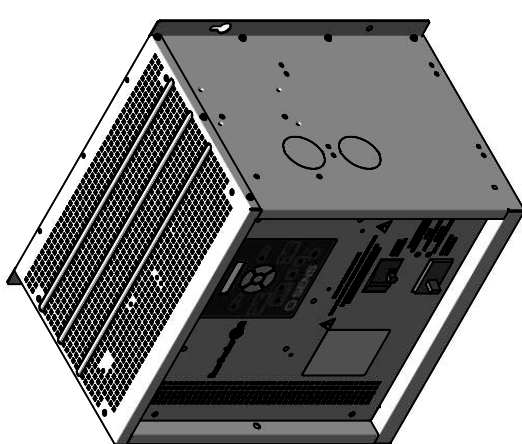

WALL MOUNT

DCN	REV	DESCRIPTION	DATE	APPROVED
108031	A	INITIAL RELEASE	4/20/2021	JWF
108104	B	SHEET 5, UPDATE JUMPER SETTINGS VIEW	8/31/2021	JWF

NAME	DATE	DESCRIPTION
JWF	4/20/2021	2DCAD, Q1, GEN2, STANDARD
JWF		C 2DCAD-Q1-GEN2-STD

DCN	REV	DESCRIPTION	DATE	APPROVED
108031	A	INITIAL RELEASE	4/20/2021	JWF
108104	B	SHEET 5, UPDATE JUMPER SETTINGS VIEW	8/31/2021	JWF

Notes:

- DO NOT attempt to remove the large laser-cut knockouts labeled "A".
- Use only the knockouts labeled "B" and "C". For holes marked "B", attach 1.0in electrical conduit. For holes marked "C", attach .75in electrical conduit.
- Allow .6in of free air space minimum top, .4in free air space bottom for for ventilation.
- Keyhole slots and holes are provided for wall mounting with 1/4in diameter hardware.
- Breaker size and ratings vary depending on charger model.

SENS
 STORED ENERGY SYSTEMS
 305-979-7900
 LONGMONT, CO 80501
 PROPRIETARY AND CONFIDENTIAL

UNLESS OTHERWISE SPECIFIED:
 DIMENSIONS ARE IN INCHES
 DEFAULT TOLERANCES:
 ANGLES ± 1°
 TWO PLACE DECIMAL ± .02
 THREE PLACE DECIMAL ± .003
 DO NOT SCALE DRAWING

PER ASME Y14.5-2009

DCN	REV	DESCRIPTION	DATE	APPROVED
---	---	See sheet 1.	---	---

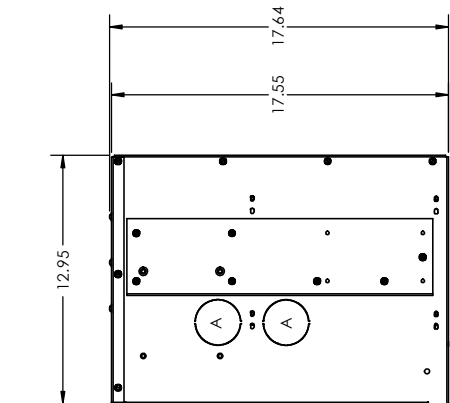

Right

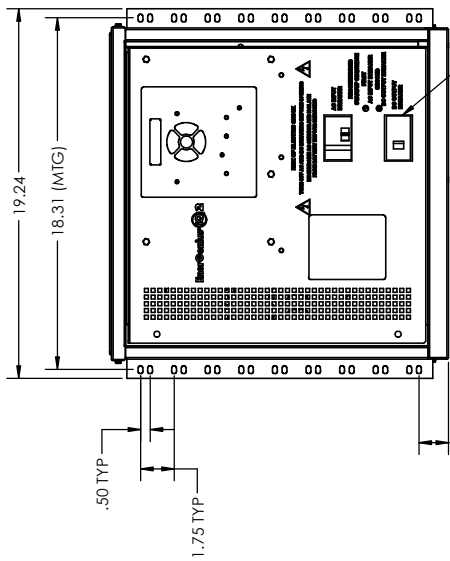

Front

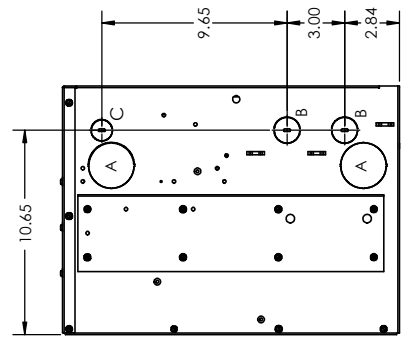

Left

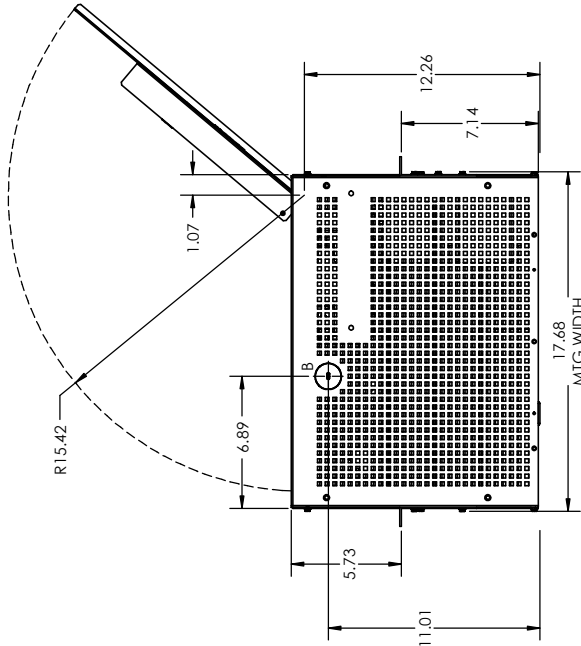

Bottom

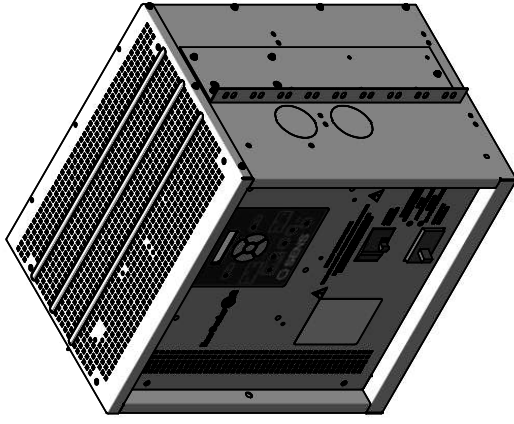

RACK MOUNT

- Notes:
- DO NOT attempt to remove the large laser-cut knockouts labeled "A".
 - Use only the knockouts labeled "B" and "C". For holes marked "B", attach 1.0in electrical conduit. For holes marked "C", attach .75in electrical conduit.
 - Allow .6in of free air space minimum top, 4in free air space bottom for ventilation.
 - Keyhole slots and holes are provided for wall mounting with 1/4in diameter hardware.
 - Breaker size and ratings vary depending on charger model.

 SENS STORED ENERGY SYSTEMS LONGMONT, CO 80501 303.679.7900 <small>PROPRIETARY AND CONFIDENTIAL</small>		UNLESS OTHERWISE SPECIFIED: DIMENSIONS ARE IN INCHES DEFAULT TOLERANCES: ANGLES ± 1° TWO PLACE DECIMAL ± .02 THREE PLACE DECIMAL ± .003 DO NOT SCALE DRAWING	NAME: JWF DATE: 4/20/2021 DRAWN: JWF CHECKED: [Signature] THIRD ANGLE PROJECTION DIMENSIONS & TOLERANCES PER ASME Y14.5-2009	DESCRIPTION: 2DCAD, Q1, GEN2, STANDARD SIZE: C DOCUMENT NUMBER: 2DCAD-Q1-GEN2-STD	REV: B SHEET 2 OF 5
---	--	--	---	---	-------------------------------

DCN		REV	DESCRIPTION	DATE	APPROVED
...	See sheet 1.

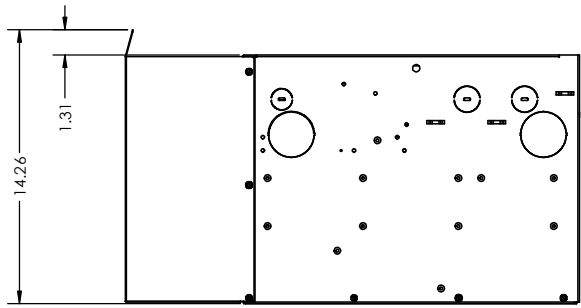

Left

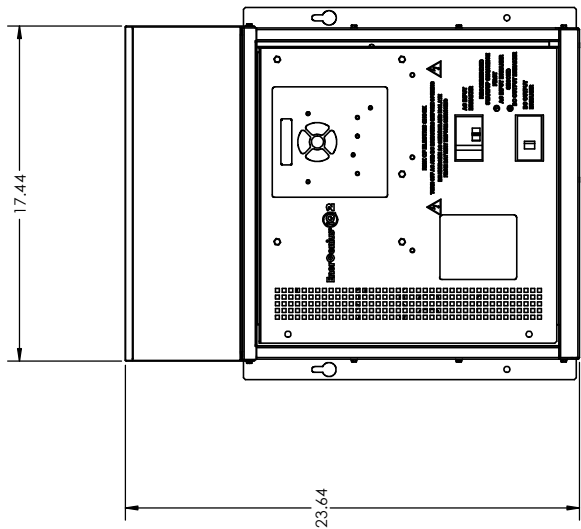

Front

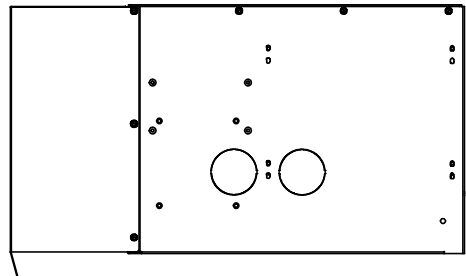

Right

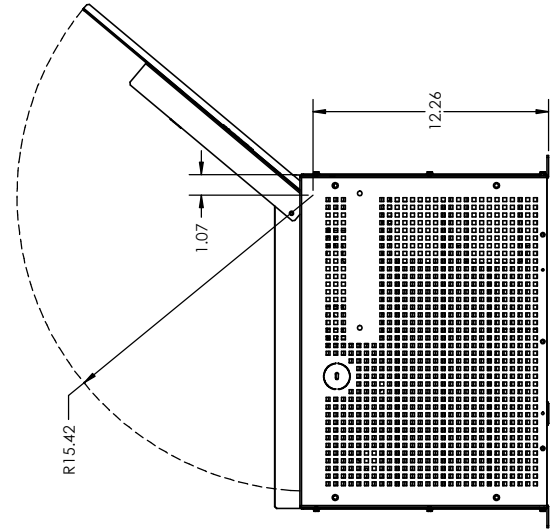
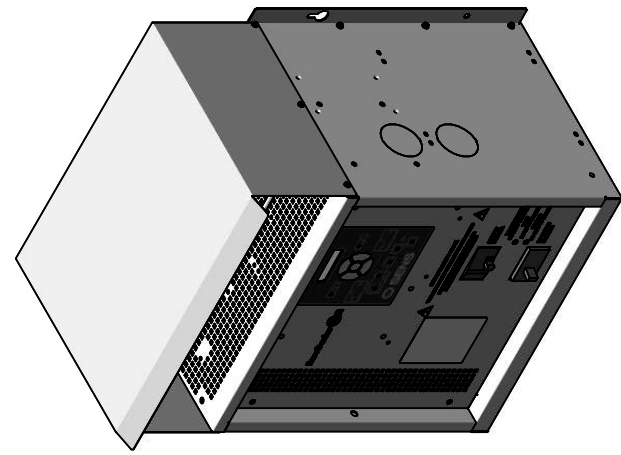

Bottom

STANDARD DRIP SHIELD

DCN	REV	DESCRIPTION	DATE	APPROVED
...	...	See sheet 1.

NAME	DATE	DESCRIPTION
JWF	4/20/2021	2DCAD, Q1, GEN2, STANDARD

SIZE	DOCUMENT NUMBER	REV
C	2DCAD-Q1-GEN2-STD	B

THIRD ANGLE PROJECTION	DIMENSIONS & TOLERANCES PER ASME Y14.5-2009
ASME Y14.5-2009	ASME Y14.5-2009

UNLESS OTHERWISE SPECIFIED:
DIMENSIONS ARE IN INCHES
DEFAULT TOLERANCES:
ANGLES ± 1°
TWO PLACE DECIMAL ± .02
THREE PLACE DECIMAL ± .003
DO NOT SCALE DRAWING

SENS
STORIED ENERGY SYSTEMS
305.979-7900
LONGMONT, CO 80501
PROPRIETARY AND CONFIDENTIAL

THE INFORMATION CONTAINED IN THIS DRAWING IS THE SOLE PROPERTY OF SENS ENERGY SYSTEMS. NO PART OF THIS DRAWING IS TO BE REPRODUCED OR TRANSMITTED IN ANY FORM OR BY ANY MEANS, ELECTRONIC OR MECHANICAL, INCLUDING PHOTOCOPYING, RECORDING, OR BY ANY INFORMATION STORAGE AND RETRIEVAL SYSTEM, WITHOUT THE WRITTEN PERMISSION OF SENS ENERGY SYSTEMS. ALL RIGHTS RESERVED.

DCN		REV	DESCRIPTION	DATE	APPROVED
...	See sheet 1.

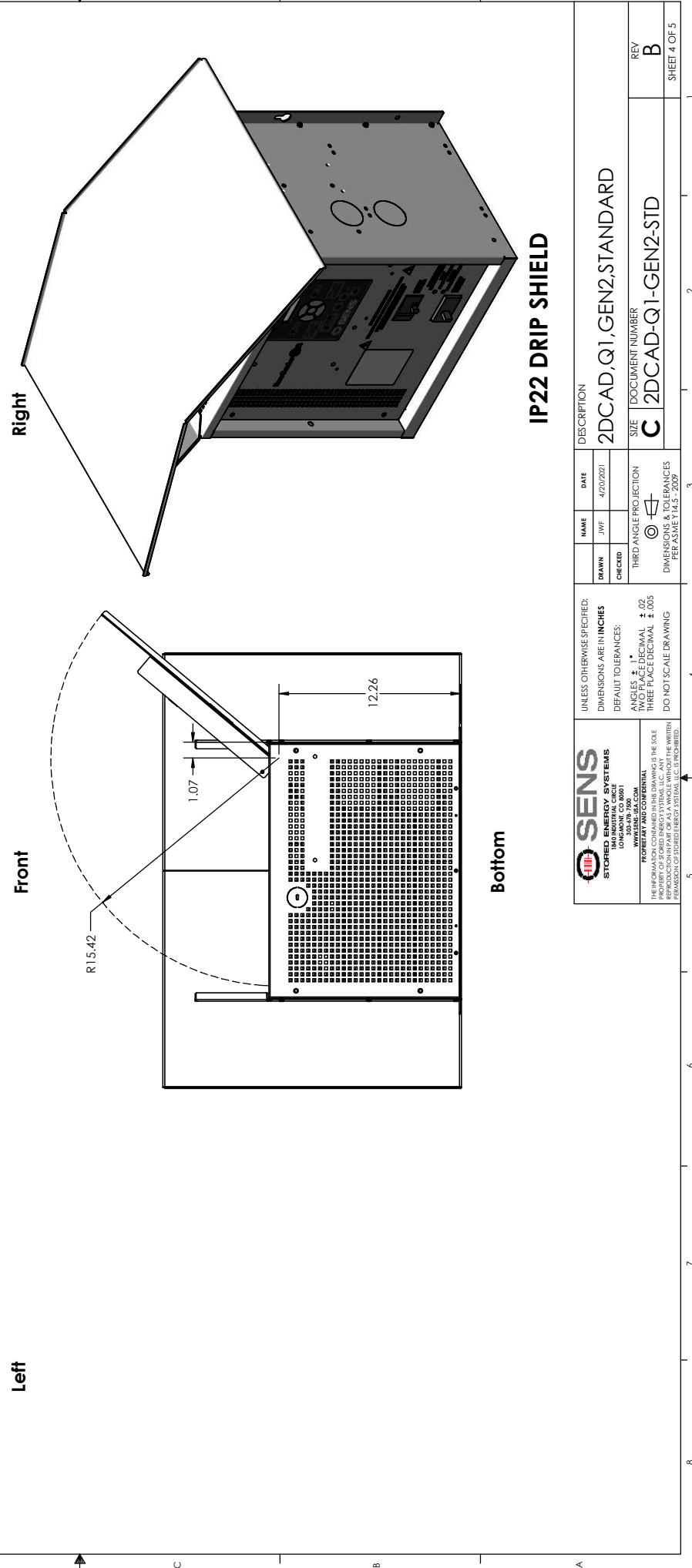
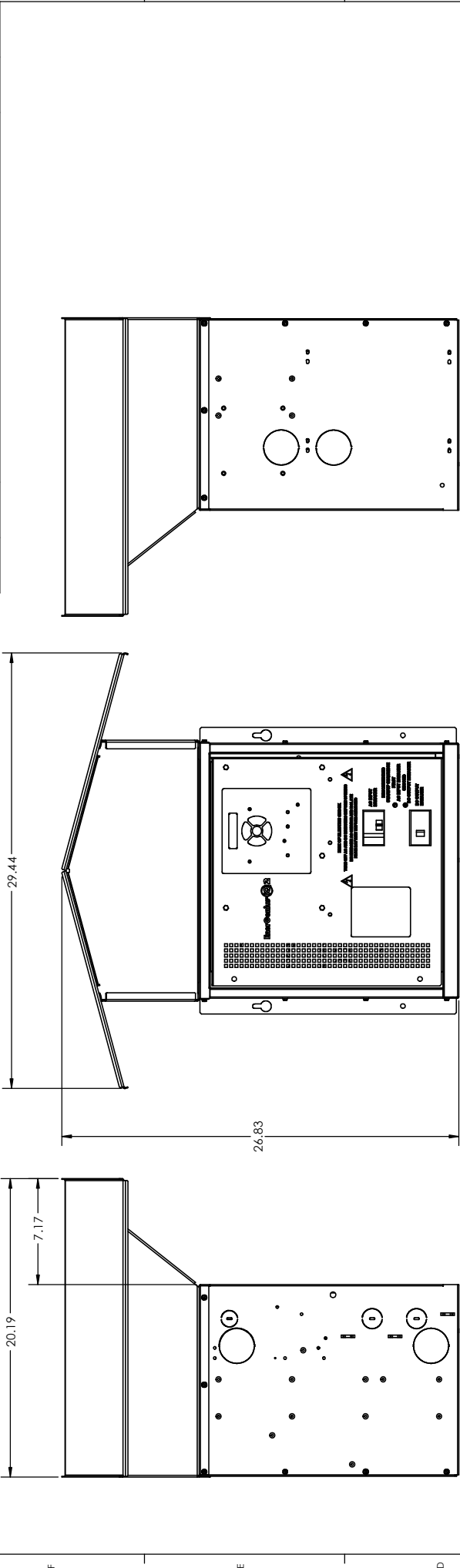

IP22 DRIP SHIELD

DRAWN		JWF	DATE	4/27/2021	DESCRIPTION	2DCAD,Q1,GEN2,STANDARD
CHECKED					SIZE	C 2DCAD-Q1-GEN2-STD
THIRD ANGLE PROJECTION					DOCUMENT NUMBER	B
DIMENSIONS & TOLERANCES PER ASME Y14.5-2009					REV	SHEET 4 OF 5

UNLESS OTHERWISE SPECIFIED:
 DIMENSIONS ARE IN INCHES
 DEFAULT TOLERANCES:
 ANGLES ± 1°
 TWO PLACE DECIMAL ± .02
 THREE PLACE DECIMAL ± .003
 DO NOT SCALE DRAWING

SENS
 STORED ENERGY SYSTEMS
 305-979-7900
 LONGMONT, CO 80501
 PROPRIETARY AND CONFIDENTIAL

THE INFORMATION CONTAINED IN THIS DRAWING IS THE SOLE PROPERTY OF SENS. IT IS TO BE USED ONLY FOR THE PROJECT AND SITE SPECIFICALLY IDENTIFIED IN THE DRAWING. REPRODUCTION OR USE FOR ANY OTHER PROJECT WITHOUT THE WRITTEN PERMISSION OF STORED ENERGY SYSTEMS IS STRICTLY PROHIBITED.

DCN	REV	DESCRIPTION	DATE	APPROVED
-	-	SEE SHEET 1	-	-

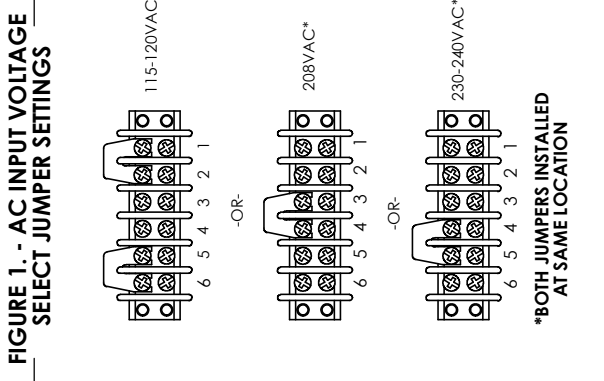

FIGURE 1 - AC INPUT VOLTAGE SELECT JUMPER SETTINGS

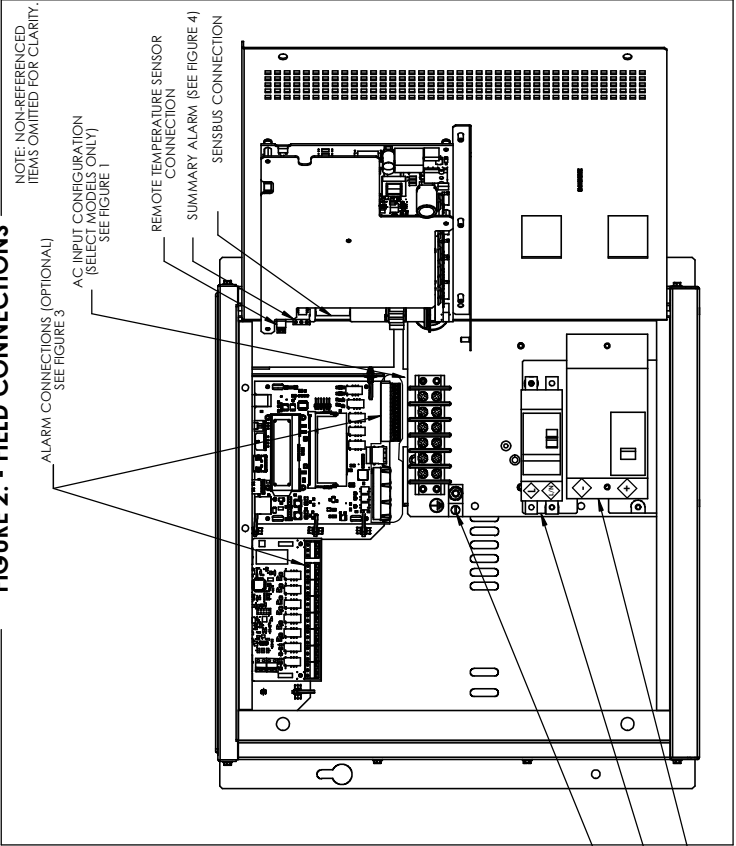

FIGURE 2 - FIELD CONNECTIONS

TABLE 1. AC INPUT CURRENT AND AC/DC CIRCUIT BREAKER CURRENT RATINGS

Charger Model	Rated AC Input Current		Charger Input Breaker Current Ratings		Output Breaker Current Ratings			
	480V 120/208/240V 50/60Hz (P) (6)	400V 120/208/240V 50/60Hz (I) (6)	480V 120/208/240V 50/60Hz (6)	120/208/240V 60Hz (I)		400V 50/60Hz (V)		
G0012-012	0.8	3.2/1.8/1.6	1	15	10	15	15	
G0012-016	1	4.2/2.4/2.1	1.2	15	10	15	20	
G0012-025	1.6	6.3/3.6/3.1	1.9	15	10	15	35	
G0012-035	2.1	8.5/4.9/4.3	2.6	15	15	15	45	
G0012-050	3.1	13.7/2.6/3	3.8	15	20	20	15	70
G0024-006	0.7	2.9/1.7/1.5	0.9	15	10	15	10	
G0024-012	1.4	5.6/3.2/2.8	1.7	15	10	15	15	
G0024-016	1.8	7.4/4.3/3.7	2.2	15	10	15	20	
G0024-025	2.9	12/6.7/5.8	3.5	15	15	15	35	
G0024-035	4	16/9.1/7.9	4.7	15	20	15	45	
G0024-050	5.6	23/13/11	6.8	15	30	15	70	
G0048-006	1.3	5.2/3.0/2.6	1.6	15	10	15	10	
G0048-012	2.6	10/5.9/5.1	3.1	15	15	15	15	
G0048-016	3.3	13.7/7.6/7	4	15	20	15	20	
G0048-025	5.2	21/12/10	6.2	15	30	15	35	
G0048-035	7.1	29/17/14	8.6	15	40	15	45	
G0048-050	10	40/23/20	12	15	50	15	70	
Q120-006	3.1	12/7.0/6.1	3.7	15	15	15	15	
Q120-012	5.9	24/14/12	7	15	30	15	15	
Q120-016	7.8	31/18/16	9.4	15	40	15	20	
Q120-025	12	47/27/24	14	15	60	20	35	
Q240-006	5.9	24/14/12	7	15	30	15	15	
Q240-012	11	44/26/23	14	15	60	20	15	

SIZE & STYLE OF AC AND DC BREAKERS MAY CHANGE DEPENDING ON CHARGER MODEL NUMBER.

TABLE 2. AC INPUT WIRE GAUGE RATINGS

Rated Charger Input	Wire Gauge	
	Min	Max
≤ 240 VAC, ≤ 24A	# 14 Cu or Al	# 2 Cu or Al
≤ 240 VAC, 60 Hz, > 24A	# 14 Cu or Al	# 2 Cu or Al
≤ 240 VAC, 50/60 Hz, > 24A	# 14 Cu, #12 Al	# 1/0 Cu or Al
> 240 VAC (All)	# 14 Cu, #12 Al	# 2 Cu, #4 Al

TABLE 3. DC OUTPUT WIRE GAUGE RATINGS

Rated Charger Output	Wire Gauge	
	Min	Max
12V - 48V	≤ 50A	# 2 Cu or Al
120V & 240V	≤ 16A	# 14 Cu, #12 Al
	≥ 25A	# 14 Cu, #12 Al

FIGURE 3 ALARM AND I/O CONNECTIONS
ALARM AND I/O CONNECTIONS ARE ASSIGNABLE AT FACTORY AND USING SENS SETUP UTILITY.

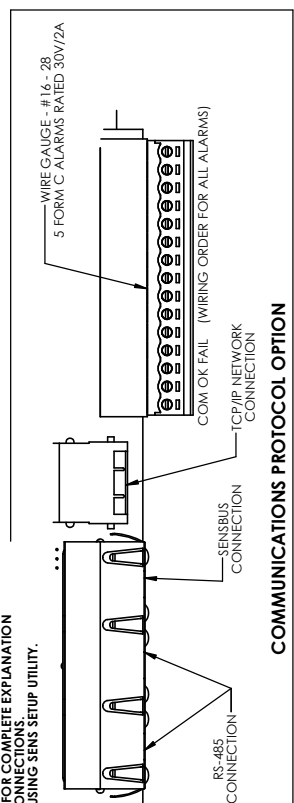
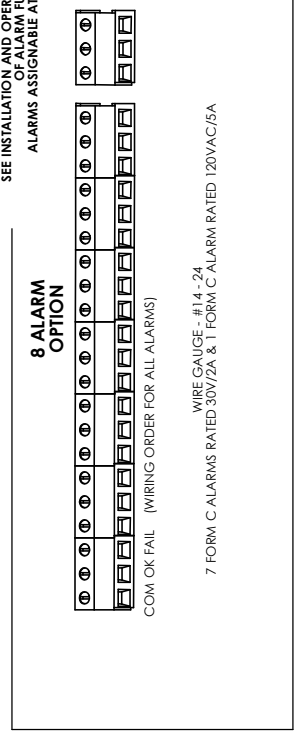

Figure 4. Control Board

Notes:

1. Polarity of breaker connections is indicated by the text enclosed in a diamond. For AC connections, "L" denotes line and "N" denotes a line or neutral connection, depending on the particular AC line configuration used.
2. Tables 2 and 3 specify only the physical capacity of the breaker terminals. In addition to physical limitations, conductors must be electrically adequate per all applicable electrical safety regulations.

SENS
STORIED ENERGY SYSTEMS
30369 790 001
LONGMONT, CO 80501
PROFESSIONAL AND CONFIDENTIAL

UNLESS OTHERWISE SPECIFIED:
DIMENSIONS ARE IN INCHES
DEFAULT TOLERANCES:
ANGLES ± 1°
TWO PLACE DECIMAL ± .02
THREE PLACE DECIMAL ± .003
DO NOT SCALE DRAWING

PER ASME Y14.5-2009

DESCRIPTION	DATE	NAME	DATE
2DCAD, Q1, GEN2, STANDARD	4/20/2021	JWF	
SIZE	DOCUMENT NUMBER	THIRD ANGLE PROJECTION	DIMENSIONS & TOLERANCES PER ASME Y14.5-2009
C	2DCAD-Q1-GEN2-STD		
REV	B		
	SHEET 5 OF 5		

Notes:

1. Allow 6 inch of free air space minimum top, 4in free air space bottom for ventilation.

4 X 3/8-16 THREADED HOLES PROVIDED FOR LIFTING HARDWARE

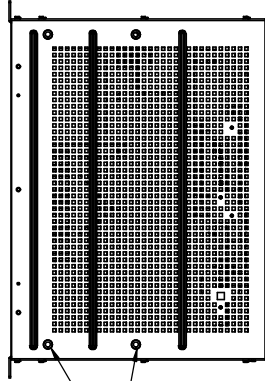
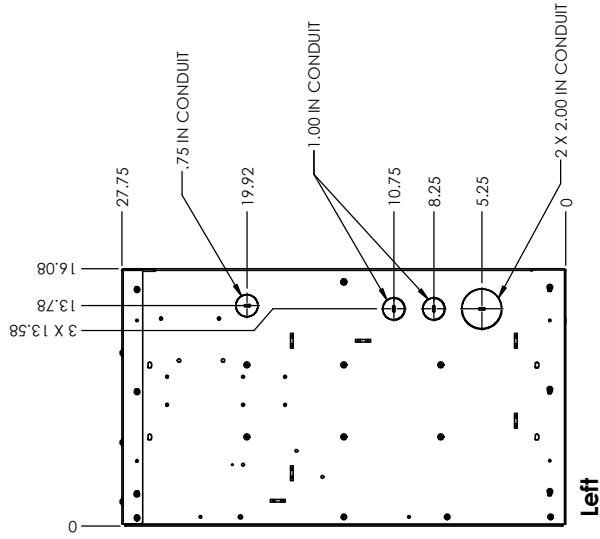

Top

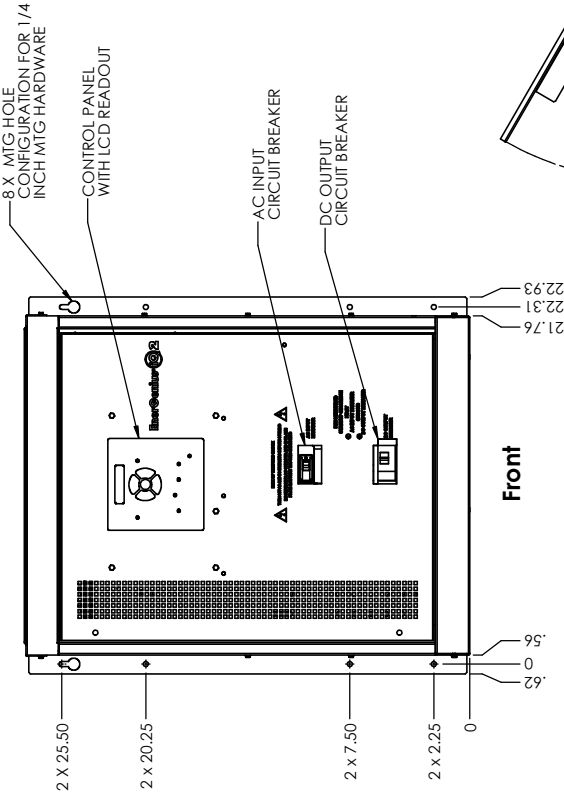

Front

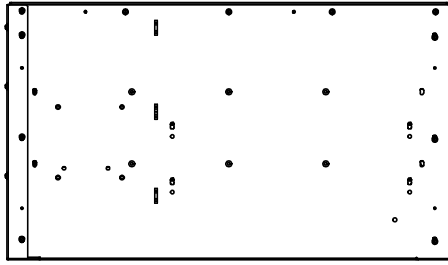

Right

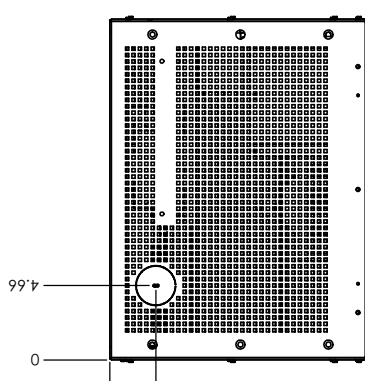
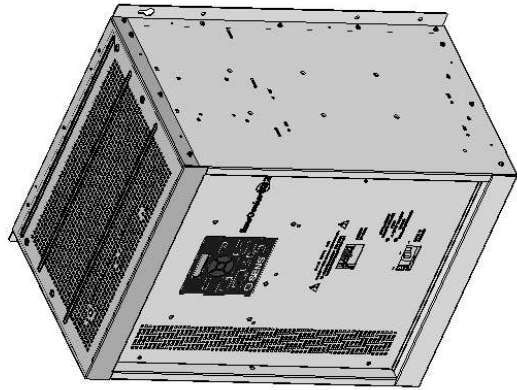

Bottom

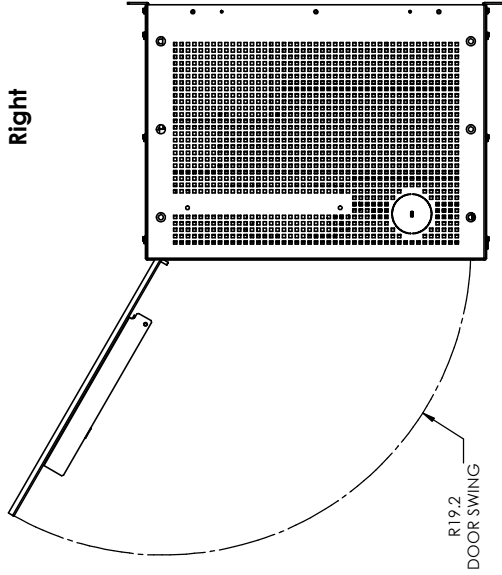

DOOR SWING
R19.2

DCN	REV	DESCRIPTION	DATE	APPROVED
108031	A	INITIAL RELEASE	4/20/2021	JWF
108104	B	SHEET 4, UPDATE JUMPER SETTINGS VIEW	8/30/2021	JWF

DCN	REV	DESCRIPTION	DATE	APPROVED
108031	A	INITIAL RELEASE	4/20/2021	JWF
108104	B	SHEET 4, UPDATE JUMPER SETTINGS VIEW	8/30/2021	JWF

NAME	DATE	DESCRIPTION
JWF	4/20/2021	2DCAD, Q2, GEN2, STANDARD

SIZE	DOCUMENT NUMBER	REV
C	2DCAD-Q2-GEN2-STD	B

THIRD ANGLE PROJECTION	DIMENSIONS & TOLERANCES PER ASME Y14.5-2009
	UNLESS OTHERWISE SPECIFIED: DIMENSIONS ARE IN INCHES DEFAULT TOLERANCES: ANGLES ± 1° TWO PLACE DECIMAL ± N/A THREE PLACE DECIMAL ± N/A DO NOT SCALE DRAWING

WALL MOUNT CONFIGURATION

REVISIONS		DATE	APPROVED
DCN	REV		
		See sheet 1.	

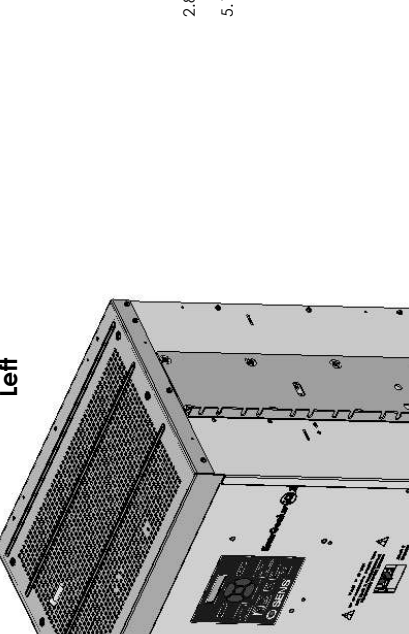
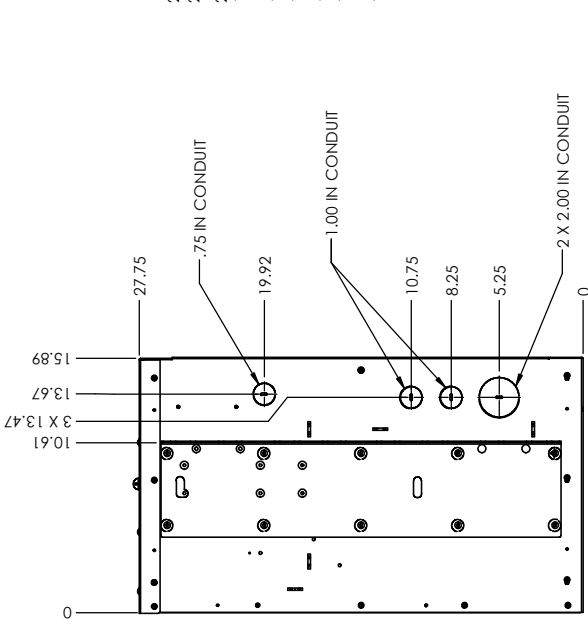
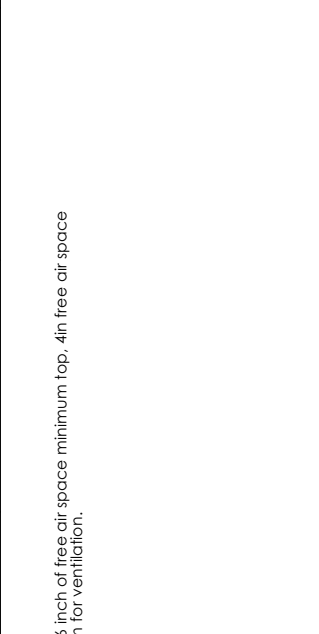
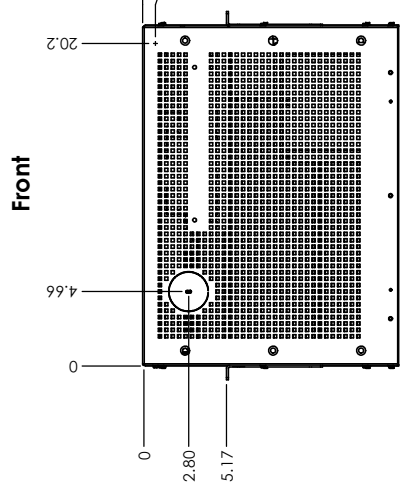
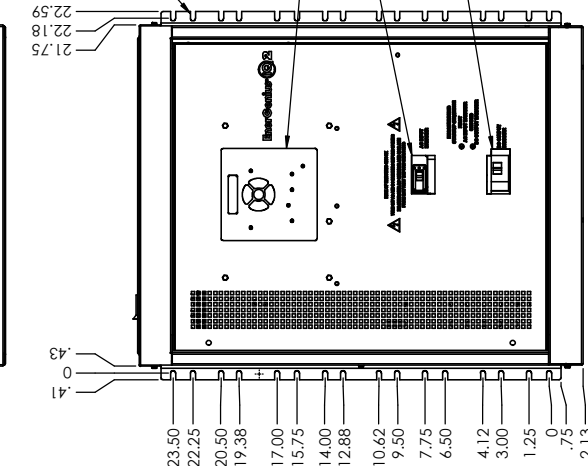
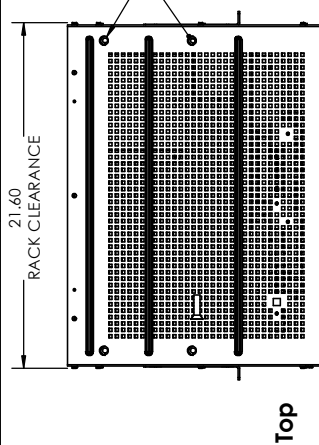

RACK MOUNT CONFIGURATION

NAME	DATE	DESCRIPTION
JWF	4/20/2021	2DCAD, Q2, GEN2, STANDARD
THIRD ANGLE PROJECTION		SIZE DOCUMENT NUMBER
		C 2DCAD-Q2-GEN2-STD
DIMENSIONS & TOLERANCES PER ASME Y14.5-2009		REV B
		SHEET 3 OF 6

UNLESS OTHERWISE SPECIFIED:
DIMENSIONS ARE IN INCHES
DEFAULT TOLERANCES:
ANGLES ± 1°
TWO PLACE DECIMAL ± N/A
THREE PLACE DECIMAL ± N/A
DO NOT SCALE DRAWING

SENS
STORIED ENERGY SYSTEMS
305.975.7400
WWW.SENS-ES.COM
LONGMONT, CO 80501

PROPRIETARY AND CONFIDENTIAL

THE INFORMATION CONTAINED IN THIS DRAWING IS THE SOLE PROPERTY OF SENS ENERGY SYSTEMS. IT IS TO BE USED FOR THE PRODUCTION OF PARTS OR AS A GUIDE WITHOUT THE WRITTEN PERMISSION OF SENS ENERGY SYSTEMS. ALL RIGHTS RESERVED.

Notes:
1. Allow 6 inch of free air space minimum top, 4in free air space bottom for ventilation.

Notes:

1. Allow 6 inch of free air space minimum top, 4in free air space bottom for ventilation.

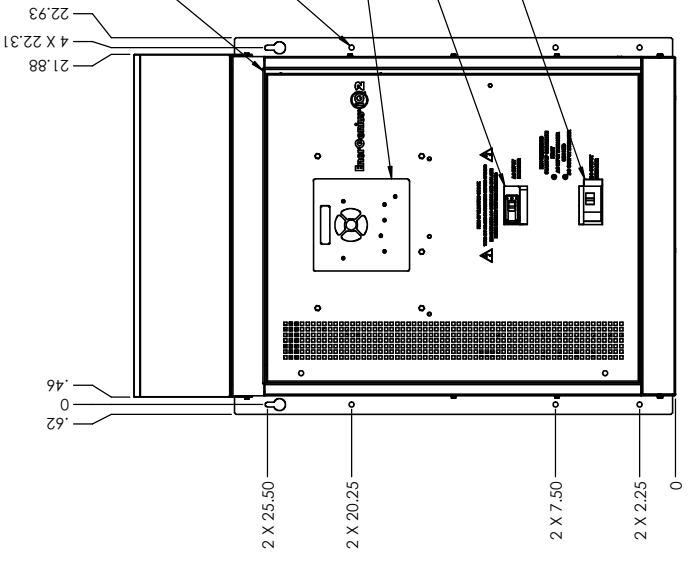
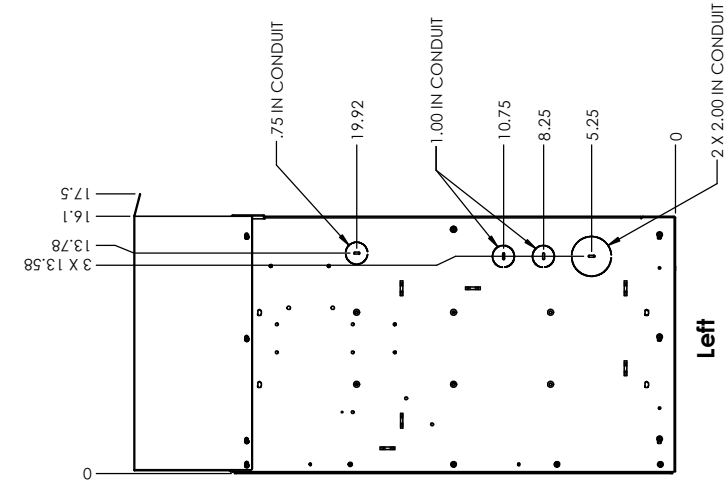

Left

Front

Right

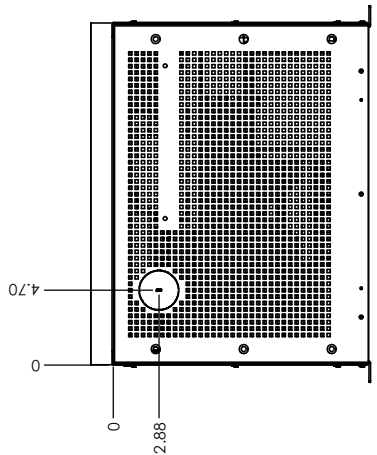

19.2 DOOR SWING

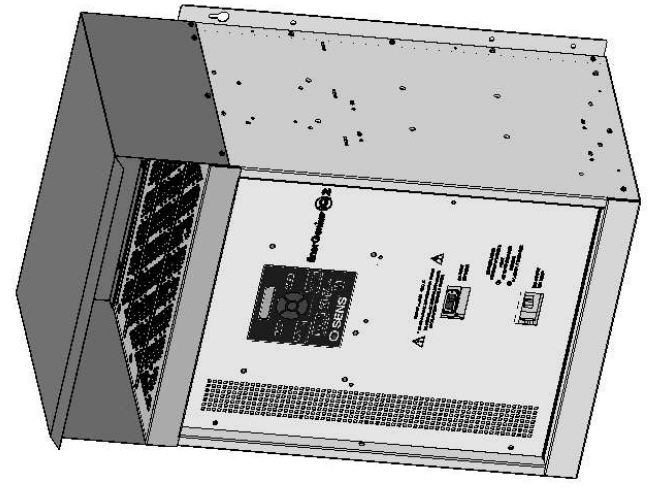

STANDARD DRIP SHIELD CONFIGURATION

DCN	REV	DESCRIPTION	DATE	APPROVED

REVISIONS		DESCRIPTION	DATE	APPROVED

		UNLESS OTHERWISE SPECIFIED: DIMENSIONS ARE IN INCHES DEFAULT TOLERANCES: ANGLES ± 1° TWO PLACE DECIMAL ± N/A THREE PLACE DECIMAL ± N/A DO NOT SCALE DRAWING	
SENS STORED ENERGY SYSTEMS 305-979-7900 LONGMONT, CO 80501 WWW.SENS.COM PROPRIETARY AND CONFIDENTIAL		DESCRIPTION 2DCAD, Q2, GEN2, STANDARD SIZE DOCUMENT NUMBER C 2DCAD-Q2-GEN2-STD REV B SHEET 4 OF 6	

Notes:

1. Allow 6 inch of free air space minimum top, 4in free air space bottom for ventilation.

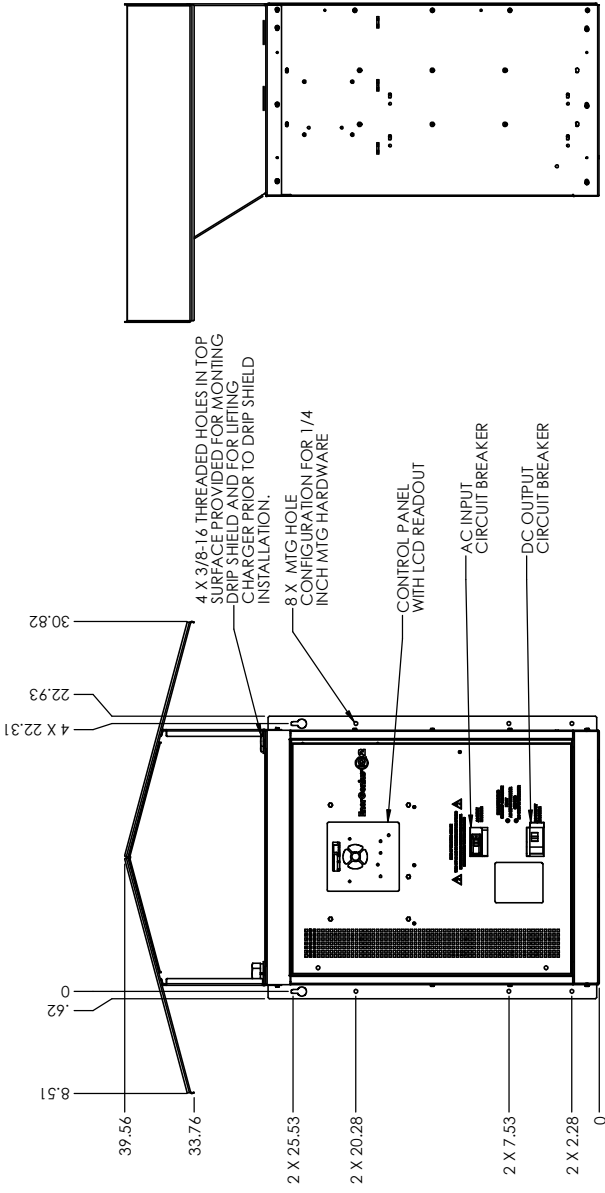
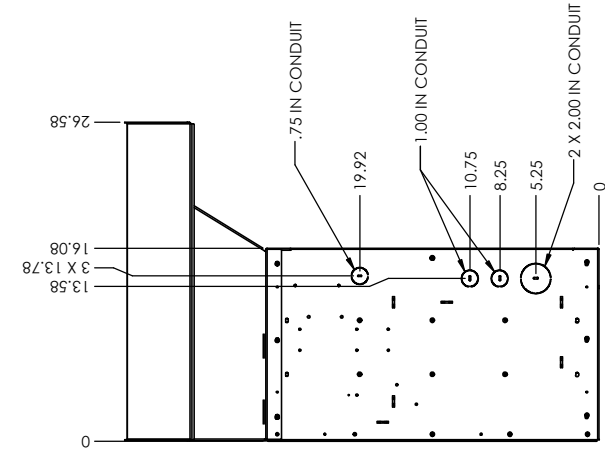

Left

Front

Right

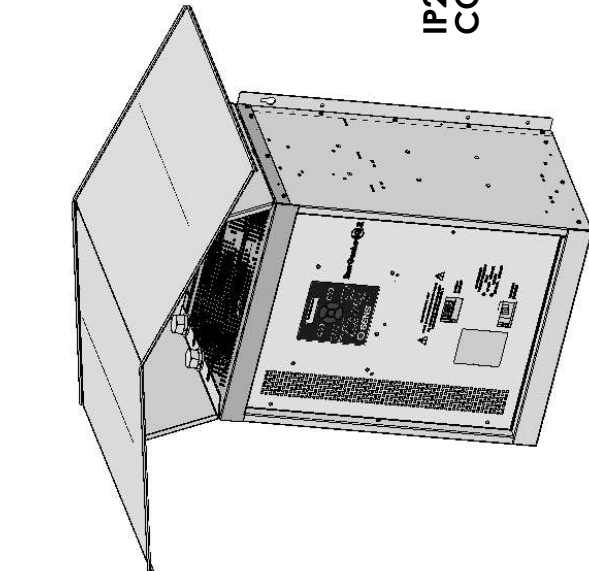

IP22 DRIP SHIELD CONFIGURATION

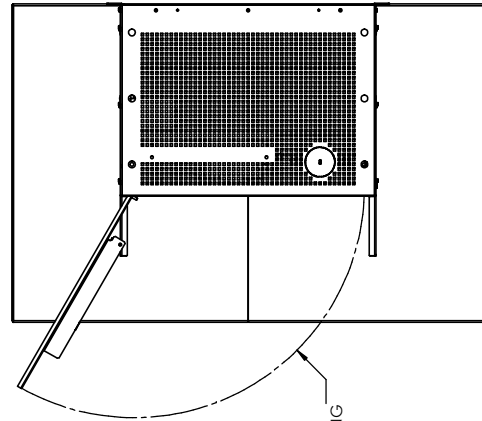
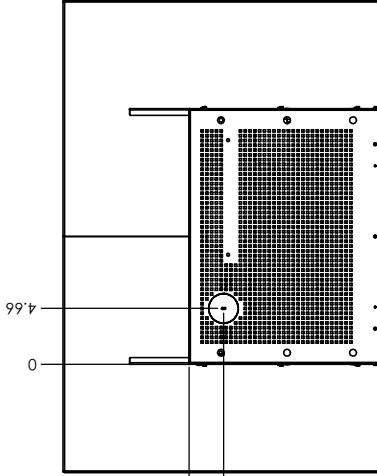

DCN	REV	DESCRIPTION	DATE	APPROVED
---	---	See sheet 1.	---	---

<p>SENS STORIED ENERGY SYSTEMS 305.979.7900 WWW.SENS.COM LONGMONT, CO 80501</p> <p><small>PROPRIETARY AND CONFIDENTIAL</small></p> <p><small>THE INFORMATION CONTAINED IN THIS DRAWING IS THE SOLE PROPERTY OF SENS ENERGY SYSTEMS. IT IS TO BE USED FOR THE REPRODUCTION PART OR AS A SINGLE WITHOUT THE WRITTEN PERMISSION OF STORIED ENERGY SYSTEMS. ALL RIGHTS RESERVED.</small></p>		<p>UNLESS OTHERWISE SPECIFIED: DIMENSIONS ARE IN INCHES DEFAULT TOLERANCES: ANGLES ± 1° TWO PLACE DECIMAL ± N/A THREE PLACE DECIMAL ± N/A DO NOT SCALE DRAWING</p>	<p>NAME: JWF DATE: 4/20/2021</p> <p>DRAWN: JWF CHECKED: [Signature]</p>	<p>DESCRIPTION: 2DCAD, Q2, GEN2, STANDARD</p> <p>SIZE: C</p> <p>DOCUMENT NUMBER: 2DCAD-Q2-GEN2-STD</p>	<p>REV: B</p> <p>SHEET 5 OF 6</p>
---	--	--	---	--	-----------------------------------

FIGURE 1
 INPUT VOLTAGE SELECTION

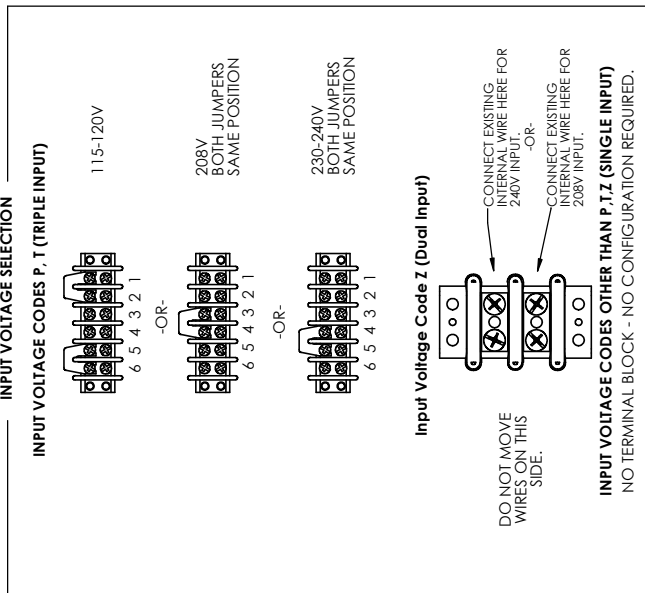

FIGURE 3
 ALARM AND I/O CONNECTIONS

SEE INSTALLATION AND OPERATION MANUAL FOR COMPLETE EXPLANATION OF ALARM FUNCTION AND CONNECTIONS.
 ALARMS ASSIGNABLE AT FACTORY AND USING SENS SETUP UTILITY.

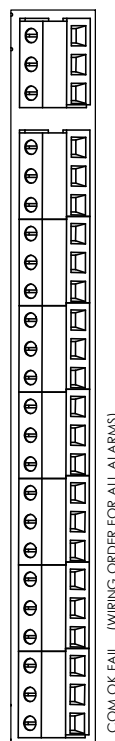
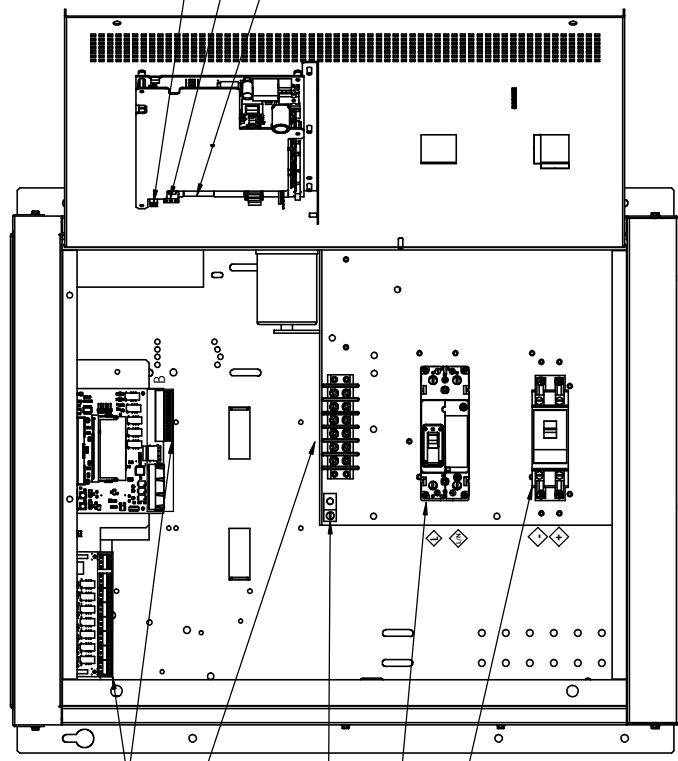

FIGURE 2
 FIELD CONNECTIONS



COMMUNICATIONS PROTOCOL OPTION

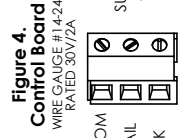
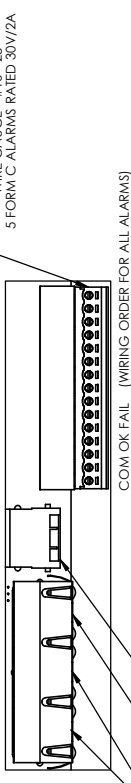

Table 2 - AC Input Wire Gauge Ratings

RATED CHARGER INPUT	WIRE GAUGE	
	MIN	MAX
≤ 240 VAC, 60 Hz	#14 Cu or Al	#2 Cu or Al
≤ 240 VAC, 50/60 Hz	#14 Cu, #12 Al	#10 Cu or Al
>240 VAC	#14 Cu, #12 Al	#10 Cu or Al
ALL 65 kAIC BREAKERS (SPECIAL ORDER)	#14 Cu, #12 Al	#10 Cu or Al

IMPORTANT INFORMATION

- SOME NON-REFERENCED ITEMS OMITTED FOR CLARITY.
- STYLE AND SIZE OF AC AND DC BREAKERS MAY CHANGE DEPENDING ON CHARGER MODEL NUMBER.
-
-

Table 3. DC OUTPUT WIRE GAUGE RATINGS

RATED CHARGER OUTPUT	WIRE GAUGE	
	MIN	MAX
12V - 48V	≤ 50A 75 & 100 A	# 14 Cu or Al # 4 Cu or Al # 2/0 Cu or Al
120V & 240V	≤ 16A ≥ 25A	# 14 Cu, #12 Al # 4 Cu or Al # 1/0 Cu or Al

NOTES TO INSTALLER

- MAKE AC AND DC CONNECTIONS DIRECT TO AC AND DC BREAKERS. LOCATION OF BREAKERS IS SHOWN. BLOCKS PER USER GUIDE INSTRUCTIONS.
- POLARITY OF BREAKER CONNECTIONS IS INDICATED BY CONNECTIONS. "L" DENOTES LINE AND "N" DENOTES A LINE OR NEUTRAL CONNECTION, DEPENDING ON THE PARTICULAR AC LINE CONFIGURATION USED.
- TABLES 2 AND 3 SPECIFY ONLY THE PHYSICAL CAPACITY OF THE BREAKER TERMINALS. IN ADDITION TO PHYSICAL CAPACITY, THE USER MUST ALSO REFER TO ALL APPLICABLE ELECTRICAL REGULATIONS.
-

Table 1 - AC Input Current and AC/DC Circuit Breaker Current Ratings

CHARGER MODEL	RATED AC INPUT CURRENT		CHARGER INPUT BREAKER CURRENT RATINGS		OUTPUT BREAKER CURRENT RATINGS	
	208V 60Hz (3)	230/240V 50/60 Hz (4)	208V 60Hz (3)	230/240V 50/60Hz (4)	400V 50/60Hz (P)	208/240V 60Hz (I)
Q012-075	N/A	N/A	N/A	N/A	15	N/A
Q012-100	N/A	N/A	N/A	N/A	15	N/A
Q012-150	N/A	N/A	N/A	N/A	15	N/A
Q024-075	N/A	N/A	N/A	N/A	15	N/A
Q024-100	N/A	N/A	N/A	N/A	15	N/A
Q024-150	37	32	37	30	25	50
Q048-075	34	30	34	25	25	45
Q048-100	45	39	45	25	30	60
Q120-035	38	33	38	25	25	50
Q120-050	54	46	54	35	35	70
Q240-016	35	30	35	25	25	45
Q240-025	54	46	54	35	35	70

SENS ENERGY SYSTEMS
 350-970-7900
 LONGMONT, CO 80501

PERMANENT AND CONFIDENTIAL

THE INFORMATION CONTAINED IN THIS DRAWING IS THE SOLE PROPERTY OF SENS ENERGY SYSTEMS. NO PART OF THIS DRAWING IS TO BE REPRODUCED OR TRANSMITTED IN ANY FORM OR BY ANY MEANS, ELECTRONIC OR MECHANICAL, INCLUDING PHOTOCOPYING, RECORDING, OR BY ANY INFORMATION STORAGE AND RETRIEVAL SYSTEM, WITHOUT THE WRITTEN PERMISSION OF SENS ENERGY SYSTEMS. © 2023

UNLESS OTHERWISE SPECIFIED:
 DIMENSIONS ARE IN INCHES
 DEFAULT TOLERANCES:
 ANGLES ± 1°
 TWO PLACE DECIMAL ± 0.02
 THREE PLACE DECIMAL ± 0.005
 DO NOT SCALE DRAWING

NAME DATE
 DRAWN JWF 4/20/2021
 CHECKED

THIRD ANGLE PROJECTION

SIZE DOCUMENT NUMBER
C 2DCAD-Q2-GEN2-STD

REV B

SHEET 6 OF 6



Confirmation of Product Type Approval

Company Name: STORED ENERGY SYSTEMS, LLC

Address: 1840 INDUSTRIAL CIRCLE CO 80501 United States

Product: Battery Charger

Model(s): EnerGenius IQ

Endorsements:

Certificate Type	Certificate Number	Issue Date	Expiry Date
Product Design Assessment (PDA)	23-2367896-PDA	10-MAR-2023	09-MAR-2028
Manufacturing Assessment (MA)	23-5820693	15-MAY-2023	30-MAY-2028
Product Quality Assurance (PQA)	NA	NA	NA

Tier

5 - Unit Certification Required

Intended Service

Charging of stationary batteries while providing clean stable DC power for continuous loads in Marine and Offshore Applications.

Description

Automatic DC Power Supply / Charger with Intelligent Battery Monitoring & Data Logging suitable for non-hazardous locations.

Model QXXXYYYYAZZZZZZ

Where XXX = DC output voltage

Options: 012, 024, 048, 120, 240

Where YYY = DC output current

Options: 006, 012, 016, 025, 035, 050, 075, 100, 150

Where A = AC input voltage

Options:

3 = 208V, 60 Hz

4 = 230-240V, 50/60 Hz

8 = 480V, 60 Hz

P = 115-120/208/230-240V, 50/60 Hz

S = 230-240V, 60 Hz

T = 115-120/208/230-240V, 60 Hz

V = 400V, 50/60 Hz

Z = 208/240V, 60 Hz

Where Z = single digit option codes

Ratings

Output Voltage: 12, 24, 48, 120, 240 VDC Nominal;

Frequency: 50/60 Hz;

Operating Temperature: -40°C to + 50°C;

Enclosure: IP 22;

Service Restrictions

1. Unit Certification is not required for this product except where used for essential or emergency services as defined by 4-8-3/5.11.1(a) of the Marine Vessel Rules or 6-1-7/19.9 of the MOU Rules.

2. If the manufacturer or purchaser request an ABS Certificate for compliance with a specification or standard, the specification or standard, including inspection standards and tolerances, must be clearly defined.

Comments

- The Manufacturer has provided a declaration about the control of, or the lack of Asbestos in this product.

- The charging facilities are to be such that a completely discharged battery is recharged to at least 80% capacity in not more than 10 hours.

- End user must use output cables that have sufficient current carrying capacity as per ABS Marine Vessel Rules 4-8-2/7.7.1.

Notes, Drawings and Documentation

Declaration of Conformity, DoC Letter, Date: March 1 2023, Pages: 1

COMPLIANCE SPEC_IQ, Specification, Date: July 20, 2021, Pages: 3

(Previous Submittals)

20140619-E117114, UL Certificate of Compliance, Date: 06-19-2014

Term of Validity

This Product Design Assessment (PDA) Certificate remains valid until 09/Mar/2028 or until the Rules and/or Standards used in the assessment are revised or until there is a design modification warranting design reassessment (whichever occurs first).

Acceptance of product is limited to the "Intended Service" details prescribed in the certificate and as per applicable Rules and Standards.

This Certificate is valid for installation of the listed product on ABS units which exist or are under contract for construction on or previous to the effective date of the ABS Rules and standards applied at the time of PDA issuance. Use of the Product for non-ABS units is subject to agreement between the manufacturer and intended client.

ABS Rules

The Rules for Conditions of Classification, Part 1 2023 Marine Vessel Rules 1-1-4/7.7, 1-1-A3, 1-1-A4, which covers the following:

2023 Marine Vessel Rules: 4-8-3/1.11.1, 4-8-3/5.9;

The Rules for Conditions of Classification, Part 1 2023 Offshore Units and Structures 1-1-4/9.7, 1-1-A2, 1-1-A3, which covers the following:

2023 Mobile Offshore Unit Rules: 4-3-3/3.1.1(a), 6-1-7/9.17.

International Standards

IEC 63000:2018

IEC 60335-1:2020

IEC 60335-2-29:2019

IEC 61000-6-2:2019

IEC 61000-6-4:2019

EU-MED Standards

NA

National Standards

UL 1012, 8th Edition

CAN/CSA 22.2 No 107.2, R2021

Government Standards

NA

Other Standards

NA



A handwritten signature in black ink, appearing to read 'James J. White', is written over the printed text.

Corporate ABS Programs
American Bureau of Shipping
Print Date and Time: 05-Jun-2023 3:02

ABS has used due diligence in the preparation of this certificate, and it represents the information on the product in the ABS Records as of the date and time the certificate is printed.

If the Rules and/or standards used in the PDA evaluation are revised or if there is a design modification (whichever occurs first), a PDA revalidation may be necessary.

The continued validity of the MA is dependent on completion of satisfactory audits as required by the ABS Rules. The validity of both PDA and MA entitles the product to receive a **Confirmation of Product Type Approval**.

Acceptance of product is limited to the "Intended Service" details prescribed in the certificate and as per applicable Rules and Standards.

This Certificate is valid for installation of the listed product on ABS units which exist or are under contract for construction on or prior to the effective date of the ABS Rules and standards applied at the time of PDA issuance. ABS makes no representations regarding Type Approval of the Product for use on vessels, MODUs or facilities built after the date of the ABS Rules used for this evaluation.

Type Approval requires Drawing Assessment, Prototype Testing and assessment of the manufacturer's quality assurance and quality control arrangements. The manufacturer is responsible to maintain compliance with all specifications applicable to the product design assessment. Unless specifically indicated in the description of the product, certification under type approval does not waive requirements for witnessed inspection or additional survey for product use on a vessel, MODU or facility intended to be ABS classed or that is presently in class with ABS.

Due to wide variety of specifications used in the products ABS has evaluated for Type Approval, it is part of our contract that; whether the standard is an ABS Rule or a non-ABS Rule, the Client has full responsibility for continued compliance with the standard.

Questions regarding the validity of ABS Rules or the need for supplemental testing or inspection of such products should, in all cases, be addressed to ABS.



Powering Critical Infrastructure

EC Declaration of Conformity

In accordance with EN ISO 17050-1:2010

Manufacturer:	Stored Energy Systems
Manufacture Address:	1840 Industrial Circle Longmont, CO 80501 U.S.A.
Product Type:	Battery Charger
Model Numbers:	QAAABBBYGXXXXXX or QAAABBBYJXXXXXX, where AA = 012, 024, 048, 110, 120, 240; BBB = 006, 012, 016, 025, 035, 050, 075, 100, 150; Y = 4, V, or P; X = any letter, digit or blank spaces
Conformance to Directives:	<p>Directive 2014/30/EU of the European Parliament and of the Council of 26 February 2014 on the harmonisation of the laws of the Member States relating to electromagnetic compatibility (recast)</p> <p>Directive 2014/35/EU of the European Parliament and of the Council of 26 February 2014 on the harmonisation of the laws of the Member States relating to the making available on the market of electrical equipment designed for use within certain voltage limits (recast)</p> <p>Commission Delegated Directive (EU) 2015/863 of 31 March 2015 amending Annex II to Directive 2011/65/EU of the European Parliament and of the Council as regards the list of restricted substances.</p>
Harmonized and/or technical specifications applied in full:	<p>Directive 2014/30/EU (EMC) EN IEC 61000-6-2:2019 EN IEC 61000-6-4:2019</p> <p>Directive 2014/35/EU (LVD) EN IEC 60335-1:2023+A11:2023 EN IEC 60335-2-29:2021+A1:2021</p> <p>Directive (EU) 2015/863 (RoHS) EN IEC 63000:2018</p>
Place and date of first issue:	Longmont, CO USA on September 23, 2009

Under the sole responsibility of Stored Energy Systems, the undersigned hereby declares that the equipment specified above conforms to the essential requirements of the above Directives(s) and Standard(s).

Sam Coleman
Compliance Manager
Stored Energy Systems, LLC

May 30, 2024
Date

UKCA Declaration of Conformity

Manufacturer:	Stored Energy Systems
Manufacture Address:	1840 Industrial Circle Longmont, CO 80501 U.S.A.
Product Type:	Battery Charger
Model Numbers:	QAAABBBYGXXXXXX or QAAABBBYJXXXXXX, where AA = 012, 024, 048, 110, 120, 240; BBB = 006, 012, 016, 025, 035, 050, 075, 100, 150; Y = 4, V, or P; X = any letter, digit or blank spaces
Conformance to Directives:	Electromagnetic Compatibility Regulations 2016 Electrical Equipment (Safety) Regulations 2016 The Restriction of the Use of Certain Hazardous Substances in Electrical and Electronic Equipment Regulations 2012 (UK RoHS)
Harmonized and/or technical specifications applied in full:	UK EMC EN IEC 61000-6-2:2019 EN IEC 61000-6-4:2019 UK Safety EN IEC 60335-1:2023+A11:2023 EN IEC 60335-2-29:2021+A1:2021 UK RoHS EN IEC 63000:2018
Place and date of first issue:	Longmont, CO USA on May 30, 2024

Under the sole responsibility of Stored Energy Systems, the undersigned hereby declares that the equipment specified above conforms to the essential requirements of the above Regulation(s) and Standard(s).



Sam Coleman
Compliance Manager
Stored Energy Systems, LLC

May 30, 2024
Date

SENS Limited Warranty

EnerGenius® IQ and EnerGenius DC Battery Chargers

What is covered?

This warranty covers any defect in material and workmanship on EnerGenius IQ and EnerGenius DC model battery chargers manufactured by Stored Energy Systems, a Colorado Limited Liability Company (SENS).

What this warranty does not cover:

This warranty does not cover damages, defects or failures of your equipment resulting from shipping damage, accidents, installation errors, unauthorized adjustment or repair, unauthorized third-party service, failure to follow instructions, misuse, fire, flood, acts of persons not in our control, and acts of God.

For how long:

Five (5) years from date of shipment.

What we will do:

If your battery charger is defective within five years of date of shipment, we will repair it or, at our option, replace it at no charge to you.

If we choose to replace your charger, we may replace it with a new or refurbished one of the same or similar design. The repair or replacement will be warranted for the remainder of the original five-year warranty period. If we determine that your charger cannot be repaired or replaced, we will refund its purchase price to you.

What we ask you to do:

Contact SENS service department to obtain warranty service instructions. To obtain warranty service the product, or if applicable the EnerGenius DC power module, must be returned, freight prepaid, to the factory under a Return Material Authorization (RMA) number provided by SENS. If, in SENS' opinion, the problem can be rectified in the field, SENS may elect to ship replacement parts for customer installation instead of having the product returned to the factory.

Limitation:

This warranty is limited to defects in material or workmanship of the product. It does not cover loss of time, inconvenience, property damage or any consequential damages. Repair, replacement or refund of the purchase price of the equipment is your exclusive remedy.